

# SG20B

## Cordless Scanner and Bluetooth Base Station



User's Guide

Intermec Technologies Corporation

Worldwide Headquarters

6001 36th Ave.W.

Everett, WA 98203

U.S.A.

[www.intermec.com](http://www.intermec.com)

The information contained herein is provided solely for the purpose of allowing customers to operate and service Intermec-manufactured equipment and is not to be released, reproduced, or used for any other purpose without written permission of Intermec Technologies Corporation.

Information and specifications contained in this document are subject to change without prior notice and do not represent a commitment on the part of Intermec Technologies Corporation.

© 2011 by Intermec Technologies Corporation. All rights reserved.

The word Intermec, the Intermec logo, Norand, ArciTech, Beverage Routebook, CrossBar, dcBrowser, Duratherm, EasyADC, EasyCoder, EasySet, Fingerprint, i-gistics, INCA (under license), Intellitag, Intellitag Gen2, JANUS, LabelShop, MobileLAN, Picolink, Ready-to-Work, RoutePower, Sabre, ScanPlus, ShopScan, Smart Mobile Computing, SmartSystems, TE 2000, Trakker Antares, and Vista Powered are either trademarks or registered trademarks of Intermec Technologies Corporation.

There are U.S. and foreign patents as well as U.S. and foreign patents pending.

# Contents

Before You Begin.....	vii
Safety Information.....	vii
Global Services and Support.....	vii
Warranty Information.....	vii
Web Support.....	viii
Send Feedback.....	viii
Telephone Support.....	viii
Service Location Support.....	viii
Who Should Read This Manual.....	ix
Related Documents.....	ix
Patent Information.....	x

<b>1 Introducing the SG20B Cordless Scanner.....</b>	<b>1</b>
What is the SG20B Cordless Scanner.....	2
Charging the SG20B.....	3
Charging Times.....	4
Checking Battery Status.....	5
Turning on the SG20B.....	5
Connecting the SG20B.....	6
Connection as a System.....	6
Direct Connection.....	6
Advantages of a Connection as a System.....	6
Scanning Bar Codes.....	7
Hands-Free Scanning.....	9
Autostand Triggering Mode.....	10
Understanding the Lights.....	11
Intermec Ready-to-Work Indicator.....	11
Status Light.....	12
Understanding the Beeps.....	13
Accessories.....	13
Required Accessories.....	13
SG20 Bluetooth Base Station.....	14
SG20B Charge Base.....	14
Optional Accessories.....	14

Desktop/Wall Mount .....	15
Desktop Adjustable Stand .....	15
Intermec USB Bluetooth Adapter .....	16

## **2 Introducing the SG20 Bluetooth Base Station** ..... 17

What is the SG20 Bluetooth Base Station .....	18
Powering the SG20 Bluetooth Base Station.....	18
Installing the SG20 Bluetooth Base Station .....	19
Unmounted Installation.....	19
Mounted Installation .....	19
Understanding the Ports.....	21
SG20 Bluetooth Base Station Recommended Connections .....	23
Understanding the Light .....	24
Accessories .....	25

## **3 Connecting the Scanner and Base Station as a System** ..... 27

Connecting the SG20 Bluetooth Base Station to a Host .....	28
USB Interface.....	28
Connecting to the USB Connector .....	28
Connecting to the 10-Pin Modular Connector.....	30
RS-232 Interface .....	31
Keyboard Wedge Interface .....	32
Connecting the SG20B Scanner to a SG20 Bluetooth Base Station .....	34
Out of Range Behavior .....	36

## **4 Configuring the Scanner and Base Station as a System** ..... 39

Basic Setup with Configuration Bar Codes .....	40
Reset Factory Defaults.....	40
USB Interface Settings.....	41
International Keyboard.....	41
USB Cable Mode.....	42
RS-232 Interface Settings .....	43
Baud Rate .....	43
Data Bits.....	44

Parity .....	44
Stop Bits .....	44
Configuring the Postamble .....	45
Postamble configuration bar codes - Scanner .....	45
Postamble configuration bar codes - Base Station .....	46
Configuring Your System with EasySet .....	47
Online Setup with EasySet .....	47
Offline Setup with EasySet .....	48

## **5 Connecting and Configuring the SG20B Scanner in Direct Connection**..... 49

Connecting the SG20B in Direct Connection .....	50
HID Bluetooth Device Connection .....	50
Pairing and Connecting as an HID Bluetooth Device .....	50
SPP Bluetooth Device Connection .....	52
Pairing as an SPP Bluetooth Device .....	53
Connecting from your Host as an SPP Bluetooth Device .....	55
Connecting from your Scanner as an SPP Bluetooth Device .....	56
Connectivity Matrix .....	56
Configuring the SG20B in Direct Connection .....	57
Basic Setup with Configuration Bar Codes .....	57
Resetting Your Scanner .....	57
Setting an International Keyboard .....	57
Configuring Your Scanner with EasySet in Direct Connection .....	60
Online Setup with EasySet .....	60
Offline Setup with EasySet .....	61

## **6 Troubleshooting and Maintaining the Scanner and Base Station** 63

Troubleshooting the SG20B and SG20 Bluetooth Base Station .....	64
Calling Product Support .....	64
Problems and Possible Solutions .....	65
Maintaining the SG20B and S20 Bluetooth Base Station .....	68
Upgrading the SG20B .....	68
Upgrading the SG20 Bluetooth Base Station .....	76
Scanner Recovery .....	80
Cleaning the SG20B .....	80
Resetting the SG20B Scanner .....	81
Replacing the SG20B Scanner Battery .....	81

<b>A</b>	<b>Specifications and Reading Distances</b> .....	85
	Scanner Specifications .....	86
	Base Station Specifications .....	89
	Reading Distances .....	90
	SG20B1D .....	91
	SG20BHP, SG20BPHC .....	92
<b>B</b>	<b>Optimizing Scanner Performance</b> .....	93
	Optimizing Decoding .....	94
	Damaged 1-Dimensional Bar Codes .....	94
	Predefined Imager Modes .....	94
	DPM Mode .....	95
	Hands-Free Scanning .....	96

# Before You Begin

This section provides you with safety information, technical support information, and sources for additional product information.

## Safety Information

Your safety is extremely important. Read and follow all warnings and cautions in this document before handling and operating Intermec equipment. You can be seriously injured, and equipment and data can be damaged if you do not follow the safety warnings and cautions.

This section explains how to identify and understand dangers, warnings, cautions, and notes that are in this document. You may also see icons that tell you when to follow ESD procedures and when to take special precautions for handling optical parts.



**A warning alerts you of an operating procedure, practice, condition, or statement that must be strictly observed to avoid death or serious injury to the persons working on the equipment.**



**A caution alerts you to an operating procedure, practice, condition, or statement that must be strictly observed to prevent equipment damage or destruction, or corruption or loss of data.**



**Note:** Notes either provide extra information about a topic or contain special instructions for handling a particular condition or set of circumstances.

## Global Services and Support

### Warranty Information

To understand the warranty for your Intermec product, visit the Intermec web site at [www.intermec.com](http://www.intermec.com) and click **Support > Returns and Repairs > Warranty**.

## **Web Support**

Visit the Intermec web site at [www.intermec.com](http://www.intermec.com) to download our current manuals (in PDF).

Visit the Intermec technical knowledge base (Knowledge Central) at [www.intermec.com](http://www.intermec.com) and click **Support > Knowledge Central** to review technical information or to request technical support for your Intermec product.

## **Send Feedback**

Your feedback is crucial to the continual improvement of our documentation. To provide feedback about this manual, please contact the Intermec Technical Communications department directly at [TechnicalCommunications@intermec.com](mailto:TechnicalCommunications@intermec.com).

## **Telephone Support**

In the U.S.A. and Canada, call **1-800-755-5505**.

Outside the U.S.A. and Canada, contact your local Intermec representative. To search for your local representative, from the Intermec web site, click **About Us > Contact Us**.

## **Service Location Support**

For the most current listing of service locations, go to [www.intermec.com](http://www.intermec.com) and click **Support > Returns and Repairs > Repair Locations**.

For technical support in South Korea, use the after service locations listed below:

### **Awoo Systems**

102-1304 SK Ventium

522 Dangjung-dong

Gunpo-si, Gyeonggi-do Korea, South 435-776

Contact: Mr. Sinbum Kang

Telephone: +82-31-436-1191

E-mail: [mjyun@awoo.co.kr](mailto:mjyun@awoo.co.kr)



**IN Information System PTD LTD**  
6th Floor  
Daegu Venture Center Bldg 95  
Shinchun 3 Dong  
Donggu, Daegu City, Korea  
E-mail: [jmyou@idif.co.kr](mailto:jmyou@idif.co.kr) or [korlim@gw.idif.co.kr](mailto:korlim@gw.idif.co.kr)

## **Who Should Read This Manual**

This *SG20B Cordless Scanner + Bluetooth Base Station User's Guide* is for the person who is responsible for installing, configuring, and maintaining the SG20B Cordless System.

This *SG20B Cordless Scanner + Bluetooth Base Station User's Guide* provides you with information about the features of the SG20 Cordless Scanner and the SG20 Bluetooth Base Station, and how to install, configure, operate, maintain, and troubleshoot them.

Before you work with the SG20B Cordless Scanner and SG20 Bluetooth Base Station, you should be familiar with your network and general networking terms, such as IP address.

## **Related Documents**

The Intermec web site at [www.intermec.com](http://www.intermec.com) contains our documents (as .pdf files) that you can download for free.

### **To download documents**

- 1** Visit the Intermec web site at [www.intermec.com](http://www.intermec.com).
- 2** Click the **Products** tab.
- 3** Using the **Products** menu, navigate to your product page. For example, to find the CN3 computer product page, click **Computers > Handheld Computers > CN3**.
- 4** Click the **Manuals** tab.

If your product does not have its own product page, click **Support > Manuals**. Use the **Product Category** field, the **Product Family** field, and the **Product** field to help you locate the documentation for your product.

*Before You Begin*

## **Patent Information**

There may be U.S. and foreign patents pending.

# 1

## Introducing the SG20B Cordless Scanner

This chapter provides an overview of the SG20B Cordless Scanner. This chapter covers these topics:

- **What is the SG20B Cordless Scanner**
- **Charging the SG20B**
- **Turning on the SG20B**
- **Connecting the SG20B**
- **Scanning Bar Codes**
- **Understanding the Lights**
- **Understanding the Beeps**
- **Accessories**

# What is the SG20B Cordless Scanner

The SG20B Cordless Scanner is a general purpose handheld scanner. The SG20B is lightweight, ergonomically designed, and uses a Bluetooth™ radio for RF communications.

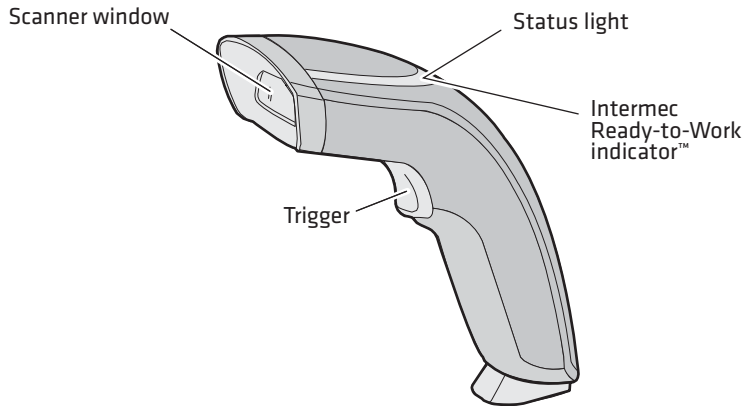

## ***SG20B Cordless Scanner***

The SG20B is available in the following models:

- 1D linear imager—SG20B1D-xxx
- High performance 2D area imager—SG20BHP-xxx
- Health Care 2D area imager—SG20BHPHC-xxx

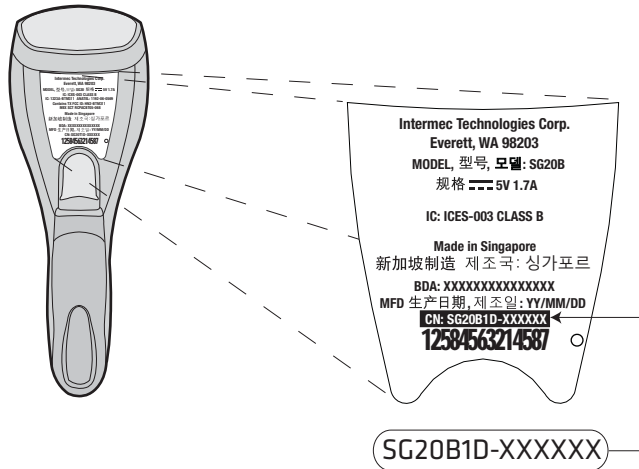

**SG20B Scan Engine Option:** The scan engine option of your SG20B can be found in the first part of the configuration number. In this illustration, the scan engine option is SG20B1D for 1D linear imager.

## Charging the SG20B

The SG20B uses a rechargeable lithium-ion battery (P/N BP-SG20-xxx) as its main power source.



**The battery pack used with this product may ignite, create a chemical burn hazard, explode, or release toxic materials if mistreated. Do not incinerate, disassemble, or heat above 100°C (212°F). Do not short circuit; may cause burns. Keep away from children.**

**Charge only in Intermec Models CB-SG20-xxx or BB-SG20-xxx. Use of incorrect charger may present a risk of fire or explosion. Promptly dispose of used battery pack according to the instructions.**

The SG20B battery can be charged using the SG20B Charge Base (P/N CB-SG20-xxx) or SG20 Bluetooth base station (P/N BB-SG20-xxx). For more information, see **“Required Accessories” on page 13**.

Make sure you fully charge the battery before you start using the SG20B. Should a problem arise with the battery, you can change it by yourself. For more information on how to replace a battery, see **“Replacing the SG20B Scanner Battery” on page 81.**

**To charge the scanner’s battery**

- Place the SG20B in a charge base or Bluetooth base station. The SG20B beeps twice and flashes green to show it is charging.

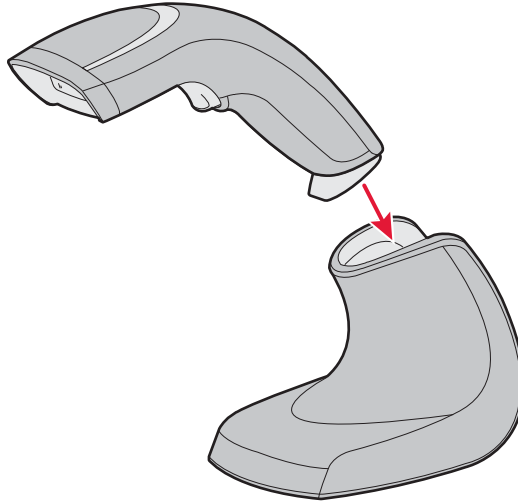

**SG20B in a Charge Base**

## **Charging Times**

Charging times differ depending on how the SG20B Charge Base or SG20 Bluetooth Base Station is powered. There are two charging times:

- Fast charge = approximately 3 hours
- Slow charge = approximately 6 hours

**Charge Base Charging Times**

<b>USB Connector</b>	<b>DC connector</b>
Slow charge	Fast charge

For more information on connecting the charge base see the *SG20B Charge Base Instructions* delivered in the box with your charge base.

### **SG20 Bluetooth Base Station Charging Times**

<b>USB Connector</b>	<b>10-Pin Modular Connector</b>	<b>DC Connector</b>
Slow charge	Fast charge	Fast charge

For more information on charging times using the base station see **“Understanding the Ports” on page 21.**

## **Checking Battery Status**

When the battery capacity remaining is lower than 20% the scanner status light flashes red approximately every 2 seconds. This means you need to charge the battery.

If your scanner is off, pull the trigger to turn it on to see the battery status.

## **Turning on the SG20B**

Use the trigger to turn on the SG20B.

### **To turn on the SG20B**

- Pull the trigger.

When you pull the trigger to turn on the SG20B, the scanner enters a discoverable state and remains discoverable for 5 minutes (before automatically shutting off, can be configured). While the SG20B is discoverable and in communications range, your host Bluetooth device can discover your SG20B and establish a Bluetooth connection.

If your SG20B is already connected to a Bluetooth device (blue Intermec Ready-to-Work indicator on), it is not discoverable.

If the status light on the SG20B flashes red when you pull the trigger to turn it on, you need to charge the battery.

## Connecting the SG20B

The SG20B cordless scanner can be connected to a host either via a SG20 Bluetooth Base Station or via the host Bluetooth interface (for example an external Bluetooth USB adapter or an internal Bluetooth controller).

### Connection as a System

In the first case, the "SG20B Scanner + SG20 Bluetooth Base Station" unit works as a single **system** (it is called "system" throughout this document). The base station acts as an interface between the scanner and the host. A system can work only if the scanner is connected to the base station via Bluetooth and if the base station is properly powered and connected to the host using the appropriate interface cables (USB, RS-232 or Keyboard wedge Y-cable). The system can then be seen as a tethered scanner, except than you can walk freely holding your scanner in your hand.

For more information on how to connect and configure a SG20B scanner as a system, see "[Connecting the Scanner and Base Station as a System](#)" on page 27 and "[Configuring the Scanner and Base Station as a System](#)" on page 39.

### Direct Connection

A scanner is said to be connected to a host in **direct connection** when it is connected to the host via a Bluetooth interface such as an external Bluetooth USB adapter or an internal Bluetooth controller.

For more information on how to connect and configure a SG20B scanner in direct connection, see "[Connecting the SG20B Scanner in Direct Connection to a Host](#)" on page 51.

### Advantages of a Connection as a System

The advantages of using your scanner as a system as opposed to a direct connection are the following:

- No need to know the Bluetooth address of the device to which to connect the scanner and to create a Bluetooth association bar code,



- No need to fit the host PC with a Bluetooth interface,
- Several interfaces available: RS-232, USB VCP, USB HID, Keyboard Wedge,
- More reliable and faster data transfer.

## Scanning Bar Codes



**For the SG20BHP and SG20BHPHC do not look directly into the window area or at a reflection of the laser framing beam while scanning. Long-term exposure to the laser framing beam can damage your vision.**

The SG20B contains either a 1D linear imager (SG20B1D) or 2D area imager (SG20BHP or SG20BHPHC) to scan bar code data. The type of scan engine you are using and the type of bar code you are decoding determines the way you scan the bar code.

When you unpack the SG20B, these bar code symbologies are enabled:

- Code 39
- Code 128 / GS1-128
- EAN/UPC
- PDF417 (SG20BHP and SG20BHPHC only)
- DataMatrix (SG20BHP and SG20BHPHC only)

If you are using bar code labels that are encoded in a different symbology, you need to enable the symbology on your SG20B. Use EasySet version 5.6.5.1 or later to enable and disable symbologies for your scanner.



**Note:** Be sure your SG20B scanner has established a Bluetooth connection with the SG20 Bluetooth Base Station (see **“Connecting the SG20B Scanner to a SG20 Bluetooth Base Station” on page 34**) or with another Bluetooth device (see **“Connecting the SG20B Scanner in Direct Connection to a Host” on page 51**). If your scanner is not connected it will emit an error beep when scanning bar codes.

**To scan a bar code label with a 1D linear imager**

- 1** Turn on your scanner by pressing the trigger.
- 2** Connect your scanner to a SG20 Bluetooth Base Station or to another Bluetooth device.
- 3** Point the SG20B at the bar code and hold the SG20B at a slight angle 5 to 25 cm (2 to 10 in) from the label.
- 4** Pull the trigger, and direct the red beam so that it falls across all bars in the bar code label.

Use this test bar code:

Code 39 Test Bar Code



\*123456\*

**Tip:** Depending on your screen resolution, you can scan bar codes displayed on your computer screen.

By default, when the SG20B successfully scans a bar code, the SG20B beeps one time, the status light turns green for 2 seconds, and the scanner beam turns off.

- 5** Release the trigger.

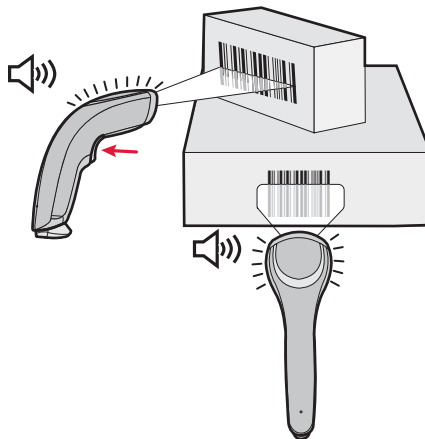

**Scanning Bar Codes:** The aiming and scanner beams that you see depend on which SG20B model you are using.

**To scan omni-directionally with the 2D high performance area imager**

- 1 Turn on your scanner by pressing the trigger.
- 2 Connect your scanner to a SG20 Bluetooth Base Station or to another Bluetooth device.
- 3 Point the scanner window at the bar code label and hold the SG20B steady a few inches from the label.
- 4 Pull the trigger and use the laser framing to position the imager over the bar code or area to capture.

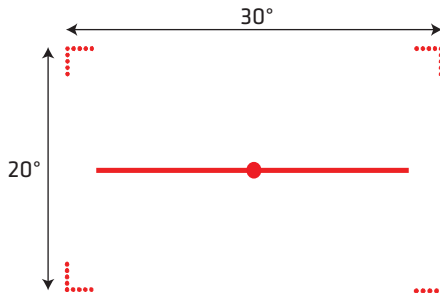

**SG20BHP/SG20BPHC Laser Framing**

By default, when the SG20B successfully scans a bar code, the SG20B beeps one time, the status light turns green for 2 seconds, and the scanner lighting turns off.



**Note:** When bar code labels are printed close to each other, try to frame only the bar code you want to read, to avoid reading the wrong bar code.

- 5 Release the trigger.

## Hands-Free Scanning

The SG20B is a handheld scanner however you can scan items without having to hold your scanner in your hand. To do hands-free scanning, you will need to change the triggering mode to Autostand. To activate, see **“Hands-Free Scanning” on page 96.**

## **Autostand Triggering Mode**

Autostand mode is different depending on the scanner model. This section explains the difference between:

- Autostand for SG20BHP/SG20BHPHC and
- Autostand for SG20B1D

### **Autostand For SG20BHP or SG20BHPHC**

Autostand is a mix of Level and Presentation triggering modes. When the scanner is not in the Charge Base or Bluetooth Base station it is in Level mode (pull the trigger to scan a bar code). When you place the scanner in a Charge Base or Bluetooth Base Station it automatically switches to Presentation mode. In this mode the scanner turns on automatically when it detects movement in front of the scanner window. This allows you to use your scanner for hands-free scanning. To return to Level mode (handheld scanning) take the scanner out the of the base.

### **Autostand For SG20B1D**

When using the 1D model Autostand is a mix of Level and Flashing triggering modes (1D model does not support Presentation mode). When the scanner is not in the Charge Base or Bluetooth Base station it is in Level mode (pull the trigger to scan a bar code). When you place the scanner in a Charge Base or Bluetooth Base Station it automatically switches to Flashing mode. In this mode the scanner is flashing. This allows you to use your scanner for hands-free scanning. To return to Level mode (handheld scanning) take the scanner out the of the base.



**Note:** Autostand mode is not available when using the Desktop Adjustable Stand because it does not provide automatic detection of the scanner. If you are using this stand with the SG20B you must also enable the Ignore Stand Detect setting using EasySet version 5.6.5.1 or later. In this case the scanner switches to Presentation/Flashing mode after a configurable timeout and is not dependant on the stand.

# Understanding the Lights

The status light and Intermec Ready-to-Work indicator on the SG20B flash red, green, amber and/or blue depending on the status of the scanner, battery and Bluetooth connection.

## Intermec Ready-to-Work Indicator

The Intermec-Ready-to-Work indicator™ (blue LED) gives information about the Bluetooth connection. When a connection has been established the the light is always on (blue) unless the scanner is docked in a Bluetooth base station or charge base. In this case the blue light turns off even though the Bluetooth connection is still active.

### ***Blue Intermec Ready-to-Work Indicator***

Light State	What it Means
Off	A Bluetooth connection has not been established. OR Scanner is docked in a base station or charge base (Bluetooth connection is active - check host to verify connection).
Blinking, slow	The scanner is trying to establish a Bluetooth connection with a Bluetooth device.
Blinking, fast	The scanner is awaiting user acknowledgement in a pairing procedure.
On	A Bluetooth connection to the base station or host computer is established. The SG20B is ready to scan bar codes and send data.

When using your scanner to scan bar codes (blue light on) your scanner will also flash status information using green, red and amber lights. See the Status Light information in the next section.

## Status Light

The status light flashes green, red or amber to indicate the status of the scanner and/or battery. Status information is sometimes shown even if the Intermec Ready-to-Work Indicator is on. This way the scanner can communicate more than one type of information at the same time.

For example while the blue LED is on to show that there is a Bluetooth connection, the scanner will flash green when you have successfully scanned a bar code.

### **Default Status Light Description**

<b>Light State</b>	<b>What it Means</b>
Green light on for 2 seconds	The scanner successfully decoded a bar code and sent the data to the host.
Green light flashes 2 times	A configuration bar code was successfully read.
Red light on for 2 seconds	Transmission error OR Configuration bar code was not accepted
Red, blinking	Battery power is low (< 20% - need to charge).
Green, blinking (only when docked)	The scanner is charging. Battery power is < 95%.
Green, on (only when docked)	Battery is fully charged.
Amber, blinking	Battery fault.

# Understanding the Beeps

The SG20B beeps to give you audio feedback when performing some functions. For example, you hear a beep each time you scan a valid bar code.

## Default SG20B Beep Descriptions

Beep Sequence	What it Means
Single beep	The SG20B successfully scanned a bar code.
Two fast beeps	The SG20B successfully scanned a configuration bar code or has been turned on.
Two beeps, bitonal	The SG20B is properly docked in the SG20B Charge Base or SG20 Bluetooth Base Station.
Six very fast beeps	Transmission error OR Configuration bar code was not accepted
Series of beeps from low to high	The SG20B is connecting to a Bluetooth host.
Series of beeps from high to low	The SG20B is disconnecting from a Bluetooth host. <b>Note:</b> The scanner does not beep when disconnecting automatically after a long period of inactivity or when reading the "Bluetooth Device Disconnect" configuration bar code.

## Accessories

The following accessories are available for your scanner.

### Required Accessories

One of the following accessories is required for your SG20B Cordless Scanner.

## **SG20 Bluetooth Base Station**

The Bluetooth base station is used to charge your scanner and connect it to a non-Bluetooth host. For more information on the base station see **“What is the SG20 Bluetooth Base Station” on page 18.**

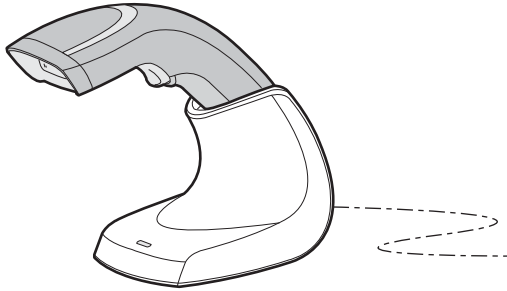

**SG20 Bluetooth Base Station:** P/N BB-SG20-xxx

## **SG20B Charge Base**

The charge base is used to charge your scanner only (no Bluetooth connection). For more information on the charge base see the *SG20B Charge Base Instructions* delivered in the box with the charge base.

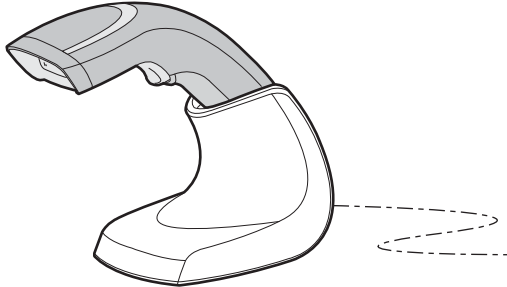

**SG20 Charge Base:** P/N CB-SG20-xxx

## **Optional Accessories**

The following accessories are optional.



## **Desktop/Wall Mount**

The desktop/wall mount holder can be used to store the SG20B when you are not using it. You can attach the holder with screws either to a desk or to a wall.

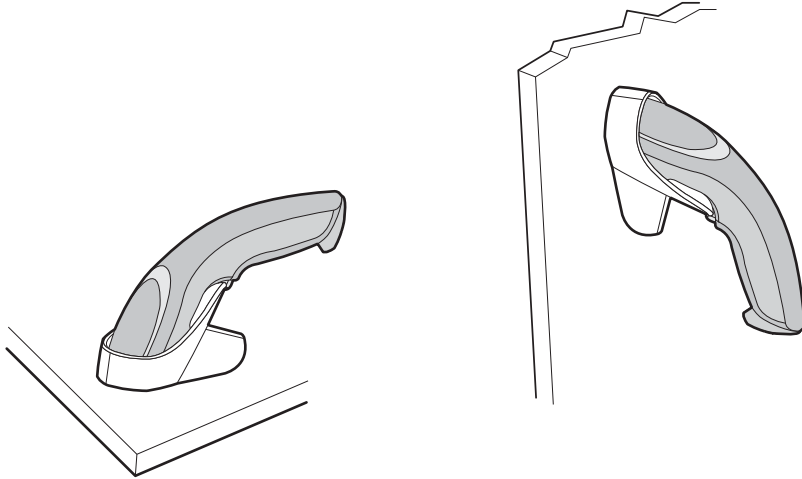

**SG20 Desktop/Wall Mount Holder:** P/N Holder-SG20-xx

## **Desktop Adjustable Stand**

The desktop adjustable stand can be used to adjust the scanning angle when using the SG20B as a hands-free scanner (must change the default trigger setting) or to store it when you are not using it.

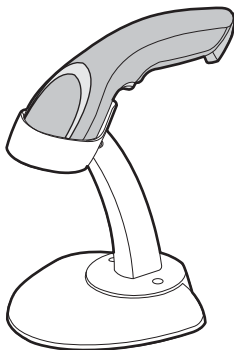

**SG20 Desktop Adjustable Stand:** P/N Stand-SG20-xx

## **Intermec USB Bluetooth Adapter**

The USB Bluetooth Adapter lets you connect your scanner to your host PC in direct connection.

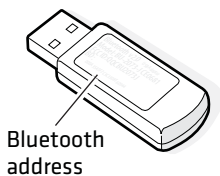

**Intermec USB Bluetooth Adapter: P/N 203-771-xx**

# 2

## Introducing the SG20 Bluetooth Base Station

This chapter provides an overview of the SG20B Bluetooth Base Station. This chapter covers these topics:

- **What is the SG20 Bluetooth Base Station**
- **Powering the SG20 Bluetooth Base Station**
- **Installing the SG20 Bluetooth Base Station**
- **Understanding the Ports**
- **Understanding the Light**
- **Accessories**

# What is the SG20 Bluetooth Base Station

The SG20 Bluetooth Base Station is used to connect an Intermec scanner to a non-Bluetooth host device. Data is transmitted from the scanner to the host via the SG20 Bluetooth Base Station. The SG20 Bluetooth Base Station is also used to charge a SG20B cordless Bluetooth scanner.

The SG20B scanner and SG20 Bluetooth Base Station are used together (in connection) as a standalone system.

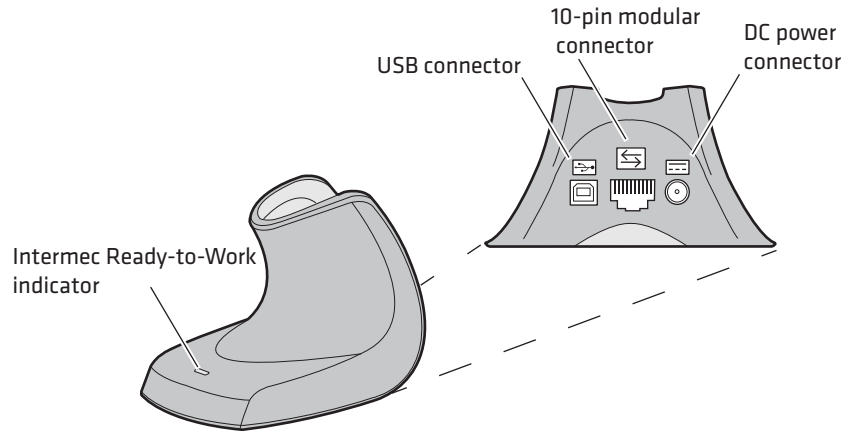

**SG20 Bluetooth Base Station**

## Powering the SG20 Bluetooth Base Station

The SG20 Bluetooth Base Station is powered through the cable connected to a host device or an external Intermec power supply. See [“Connecting the SG20 Bluetooth Base Station to a Host” on page 28](#) for connection details.



**Note:** You cannot power the SG20 Bluetooth Base Station using a standard USB cable plugged in a power outlet via a USB power adapter.

# Installing the SG20 Bluetooth Base Station

You can choose an unmounted installation or mounted installation for the base station.

Provided in the box:

- Self-adhesive rubber feet (unmounted option)
- Double-sided foam tape (mounted option)

Not provided:

Mounting hardware appropriate for the thickness of the mounting surface (mounted option)

## Unmounted Installation

For an unmounted installation apply the rubber feet (provided) to their positions under the base.

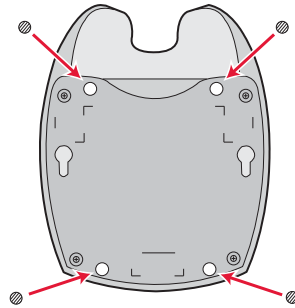

***SG20 Bluetooth Base Station Rubber Feet Locations***

## Mounted Installation

For a mounted installation apply the foam tape (provided) or use mounting hardware (not provided).

### **To install using double-sided foam tape**

- 1** Remove the protective film from one side of the double-sided tape and position onto tape locations.

## Chapter 2 – Introducing the SG20 Bluetooth Base Station

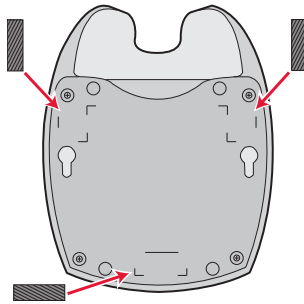

### **SG20 Bluetooth Base Station Tape Locations**

- 2 Remove the protective films from other sides.
- 3 Place the base station on a flat and clean mounting surface and push firmly.

### **To install using mounting hardware**

- 1 Drill two holes in the mounting surface at a distance of 8.4 cm (3.3 in) and install mounting hardware.
- 2 Mount the base station.

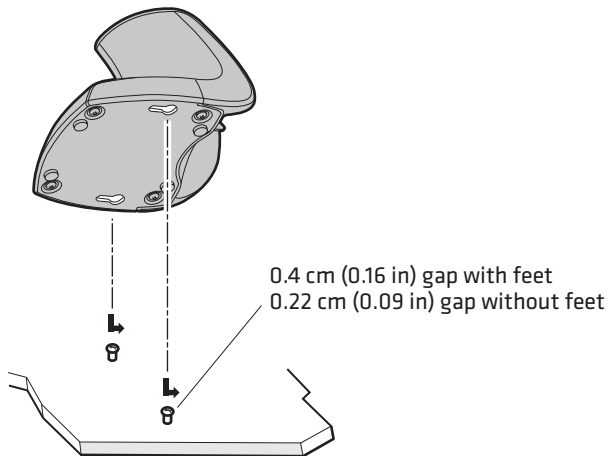

### **Mounting the SG20 Bluetooth Base Station with Hardware**

# Understanding the Ports

The SG20 Bluetooth Base Station has three ports which are described in the following table.

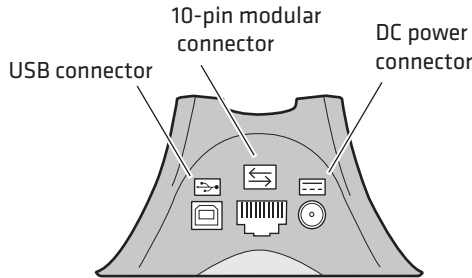



**SG20 Bluetooth Base Station Ports**

## SG20 Bluetooth Base Station Port Description

Port	Description
USB connector Symbol: 	Used to transmit data as well as receive host commands (via EasySet) and charge a scanner.  The host USB port must provide 500 mA to power the base station and charge a scanner (slow charge—6 hrs) on this port. If not possible or to charge the scanner in fast charge you will need to use an Intermec external power supply connected to the DC connector.  <b>Note:</b> You cannot charge a scanner by plugging a standard USB cable in a power outlet via a USB power adapter.

**SG20 Bluetooth Base Station Port Description**

<b>Port</b>	<b>Description</b>
10-Pin modular connector Symbol: 	Used to connect any SG20 scanner cable (powered & non-powered): <ul style="list-style-type: none"><li>• USB cable (non-powered)—Used to transmit data and receive host commands (via EasySet). To charge a scanner (fast charge—3 hrs) you must connect an external power supply on the DC connector on the base.</li><li>• Keyboard wedge Y-cable (non-powered)—Used to send data to a data collection application. To charge a scanner (fast charge—3 hrs) you must use an external power supply connected to the DC connector on the base.</li><li>• RS-232 cable (powered)—Used to transmit data and receive host commands (via EasySet). The RS-232 cable requires a power supply connected to the cable. This power supply provides power to charge a scanner (fast charge—3 hrs). No power needed on the base DC connector.</li></ul>
DC connector Symbol: 	Used to connect an Intermec power supply unit and charge a scanner (fast charge—3 hrs).



## SG20 Bluetooth Base Station Recommended Connections

The figure below shows the recommended connection configurations to charge and/or interface with a SG20B scanner.

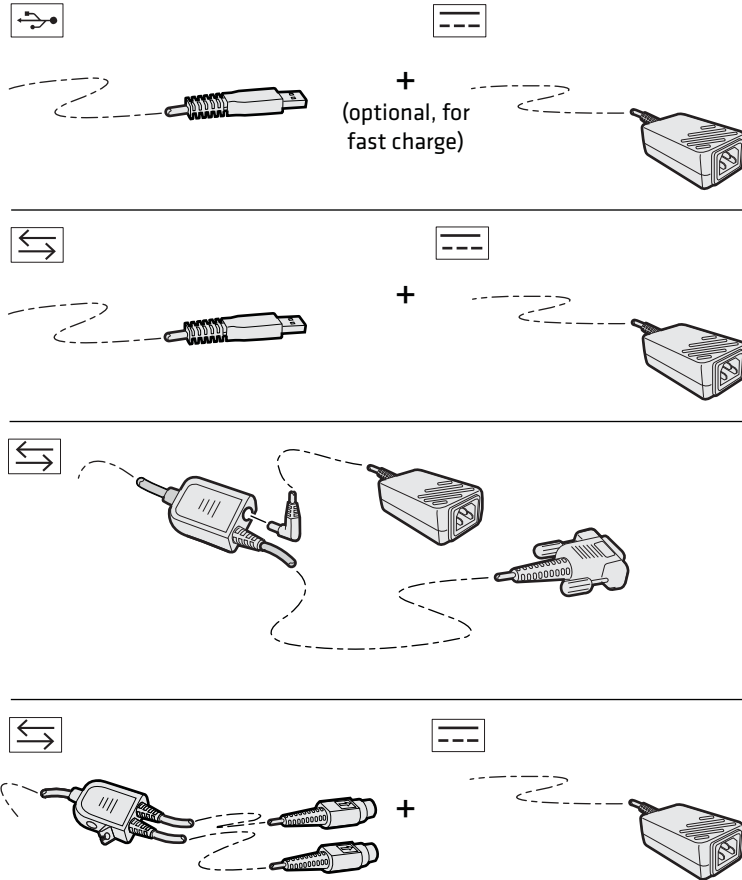

**SG20 Bluetooth Base Station Recommended Connections**

# Understanding the Light

The SG20 Bluetooth Base Station has a blue Intermec Ready-to-Work™ light. This light is used to indicate the status of the Bluetooth and host connection as well as data transmission.



**SG20 Bluetooth Base Station Ready-to-Work Light**

## **Blue Intermec Ready-to-Work Indicator Description**

Light State	What It Means
2 flashes	Power-up
On	A Bluetooth connection has been established. The SG20 Bluetooth Base Station is ready to receive data from the scanner.
1 blink off	Data has been successfully transmitted to the host.
Slow blinking	Connection is incomplete (cannot charge and/or interface with the scanner). See figure “ <b>SG20 Bluetooth Base Station Recommended Connections</b> ” on page 23.
Off	A Bluetooth connection has not been established.

# Accessories

You will need one or more of the following cables for your SG20 Bluetooth Base Station.

## **SG20 Bluetooth Base Station Cable List**

<b>Cable</b>	<b>Part Number</b>
SG20 USB cable (non-powered)	CAB-SG20-USBxxx
SG20 Keyboard wedge cable	CAB-SG20-KBWxxx
SG20 RS-232 cable	CAB-SG20-SERxxx
Universal Intermec power supply 5V	851-089-xxx



**Note:** A power cord is also needed to plug in the power supply. The power cord needed depends on your country and is sold separately.

**Chapter 2 – Introducing the SG20 Bluetooth Base Station**

# 3

## Connecting the Scanner and Base Station as a System

This chapter explains how to connect the SG20 Bluetooth Base Station to a host and how to connect the SG20B to a SG20 Bluetooth Base Station. This chapter covers these topics:

- **Connecting the SG20 Bluetooth Base Station to a Host**
- **Connecting the SG20B Scanner to a SG20 Bluetooth Base Station**

# Connecting the SG20 Bluetooth Base Station to a Host

The SG20 Bluetooth Base Station is connected to a host device using different cables depending on the interface for your application.

This section provides information on the following interfaces:

- USB
- RS-232
- Keyboard Wedge

## USB Interface

For a USB interface a standard or Intermec SG20 USB cable is connected to the USB connector or to the 10-pin modular connector. See **“Accessories” on page 25** for a list of available cables.

The default USB interface is Keyboard HID. To switch to Virtual Com Port mode, see **“USB Cable Mode” on page 42**.

### Connecting to the USB Connector

Use a standard USB cable to connect from the USB connector of the base station to the USB port of your host. The host must provide 500 mA to power the base station and charge a scanner by slow charge. To charge a scanner by fast charge you must also connect an external power supply to the DC connector.

**To connect a USB cable to the USB connector**

- 1 Connect a standard USB cable to the USB connector of the base station and to the host.

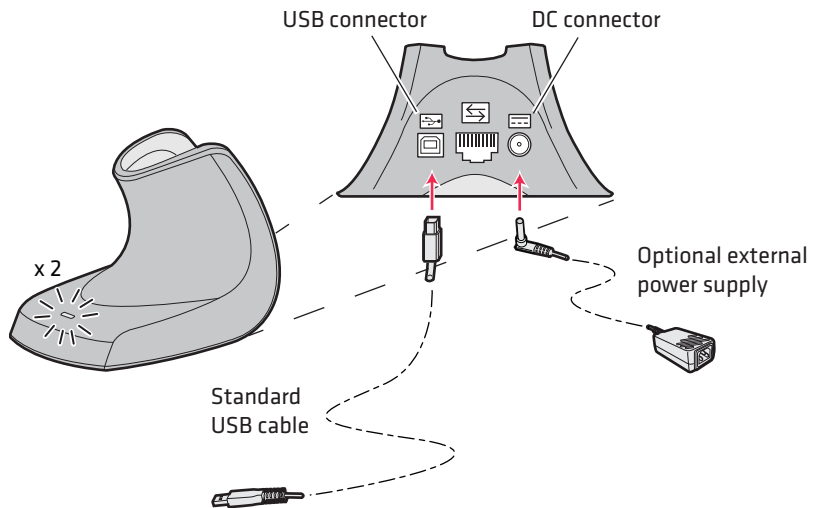

**SG20 Bluetooth Base Station USB Connection on USB Connector**

- 2 Connect the power supply (optional) to the DC connector and to an AC power outlet.
- 3 If your host device is off, turn it on. The SG20 Bluetooth Base Station is successfully connected and power is on when the blue light flashes 2 times.



**Note:** If you do not use an external power supply you may get a message that the host does not provide enough power. In this case use a different hub or disconnect other USB devices. The host must provide 500mA from the USB port to power the base station and charge a scanner by slow charge.

- 4 If necessary, configure your SG20 Bluetooth Base Station for an International keyboard using EasySet. The default keyboard is North America (for additional keyboards, see **“International Keyboard” on page 41**).

## Connecting to the 10-Pin Modular Connector

Use an Intermec SG20 USB cable to connect from the 10-pin modular connector of the base station to the USB port of your host.

An external power supply to the DC connector is required.

### To connect a USB cable to the 10-pin modular connector

- 1 Connect an Intermec SG20 USB cable to the 10-pin modular connector of the base station and to the host.

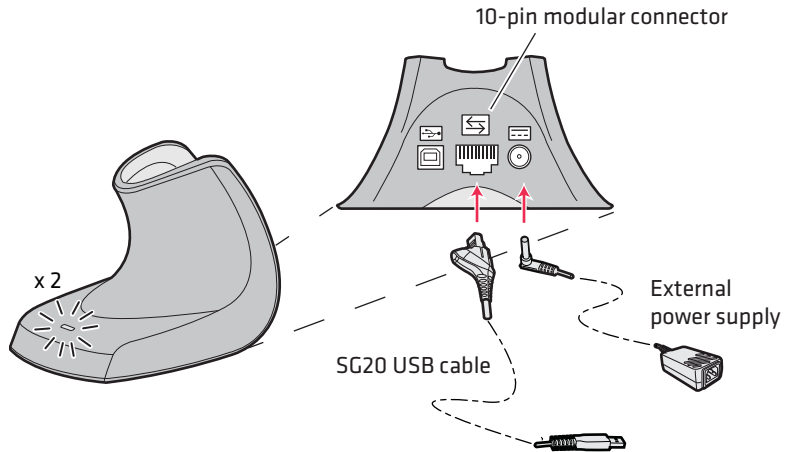

### SG20 Bluetooth Base Station USB Connection on 10-pin Modular Connector

- 2 Connect the power supply to the DC connector and to an AC power outlet.
- 3 If the host is turned off, turn it on. The SG20 Bluetooth Base Station is successfully connected and power is on when it emits 2 blue flashes.
- 4 If necessary, configure your SG20 Bluetooth Base Station for an International keyboard using EasySet. The default keyboard is North America (for additional keyboards, see **“International Keyboard”** on page 41).



## RS-232 Interface

For an RS-232 interface the RS-232 cable is connected to the 10-pin modular connector and requires an external power supply connected to the RS-232 cable. See “**Accessories**” on page 25 for a list of part numbers for the different cables.

An RS-232 cable provides power to charge a scanner by fast charge.

The default RS-232 serial parameters for the SG20 Bluetooth Base Station are:

Baud Rate: 57600

Data Bits: 8

Parity: none

Stop Bits: 1

### To connect an RS-232 cable

- 1 Turn off your host device.
- 2 Connect the RS-232 cable to the 10-pin modular connector of your base station and connect to the host device.

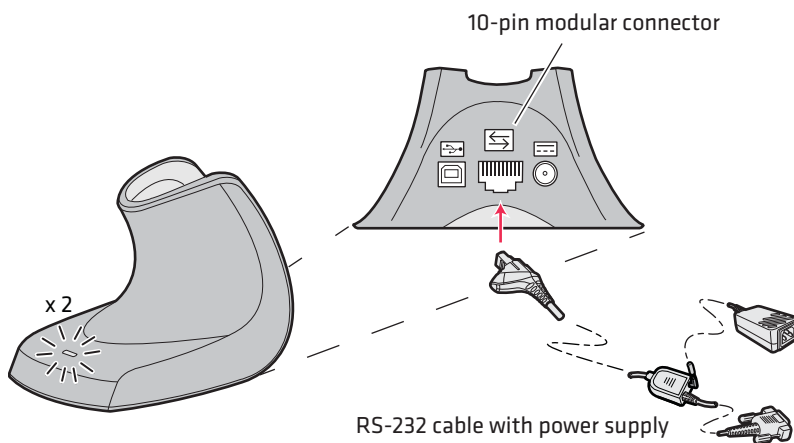

### SG20 Bluetooth Base Station RS-232 Connection

- 3 Connect the power supply to the RS-232 cable and an AC power outlet.
- 4 Turn on the host device.

The SG20 Bluetooth Base Station is successfully connected and power is on when it emits 2 blue flashes.

- 5 If necessary, configure the serial parameters of your base station using EasySet to match the host device (for more information on serial parameters setup, see **“RS-232 Interface Settings” on page 43**).

## Keyboard Wedge Interface

For a keyboard wedge interface the keyboard wedge Y-cable is connected to the 10-pin modular connector. If your host does not provide enough power you can connect an external power supply to the Y-cable. This will power your base station but will not provide enough power to charge a scanner in the base. To charge a scanner (fast charge) you must connect an external power supply to the DC connector.

### To connect with a keyboard wedge Y-cable

- 1 Turn off your host device.



**Do not connect a keyboard wedge Y-cable to a host that is turned on. You may damage your product.**

- 2 Connect the Y-cable to the 10-pin modular connector of your base station and to the host device (one end to the host and the other to a PS2 keyboard).

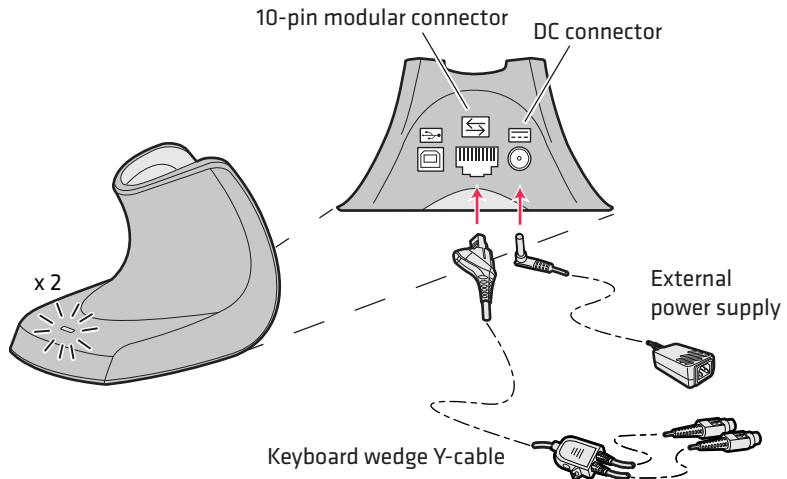

**SG20 Bluetooth Base Station Keyboard Wedge Y-Cable connection**

- 3** Connect the external power supply.
- 4** Turn on your host device.

The SG20 Bluetooth Base Station is successfully connected and power is on when it emits 2 light flashes.

- 5** If necessary, configure your SG20 Bluetooth Base Station for an International keyboard. The default keyboard is North America (for additional keyboards, see **“International Keyboard” on page 41**).

# Connecting the SG20B Scanner to a SG20 Bluetooth Base Station

You can use Bluetooth radio communication to connect your SG20B scanner to the SG20 Bluetooth Base Station.

When your base station is connected to your host and your scanner is connected to your base station, they can be seen together as a single system, such as a tethered scanner.

## **To connect a scanner to the base station**

- 1** Connect the SG20 Bluetooth Base Station to a host device using the correct cable for your interface (see **“Connecting the SG20 Bluetooth Base Station to a Host” on page 28**).
- 2** Turn your SG20B on by pressing the trigger.
- 3** Read the Bluetooth association bar code on the bottom of the SG20 Bluetooth Base Station.

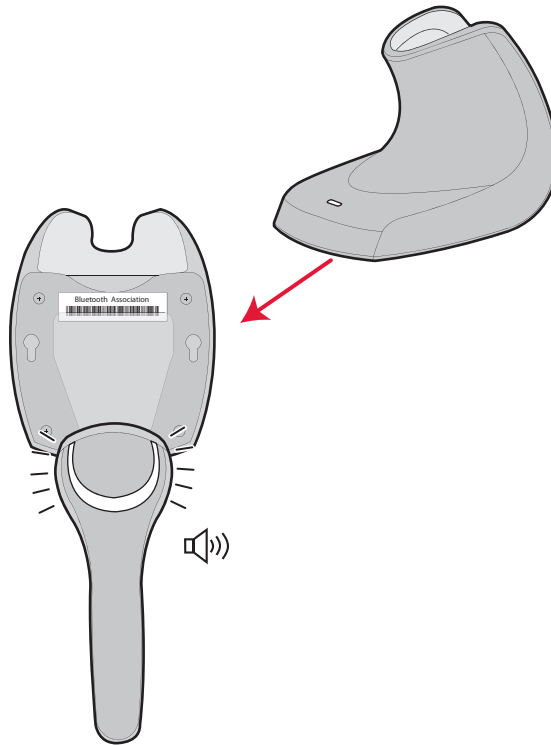

***Connecting the SG20B to the SG20 Bluetooth Base Station***

The scanner beeps twice, the green status light flashes twice and the blue Intermec Ready-to-Work indicator starts blinking. When the scanner connects to the base station it emits a series of beeps from low to high. The blue Intermec Ready-to-Work indicator turns on and stays on for both the scanner and base station.

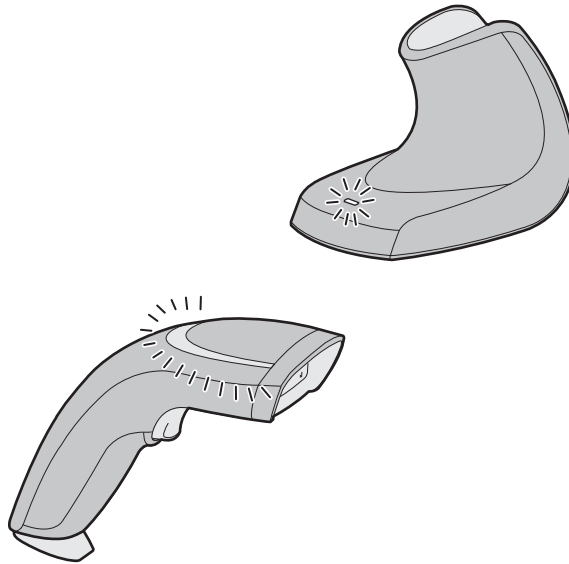

**Bluetooth Connected—Intermec-Ready-to-Work Indicator On**

Your scanner is ready to scan data.



**Note:** If you cannot read the association bar code located on the bottom of the base station you will need to create an association bar code using EasySet, see **“Configuring Your System with EasySet” on page 47.**

## **Out of Range Behavior**

If the Bluetooth connection is lost (out of range, scanner battery too low, etc.) the scanner and base station will automatically try to reconnect once the problem is resolved (back in to range, recharge scanner battery, etc.). If you try to read a bar code while the scanner is disconnected from the base station, the scanner will emit an error beep.

No data is stored in the buffer, meaning that no data can be lost when the scanner loses connection with the base station.

**To disconnect a scanner from the base station**

- Scan this bar code:

Bluetooth Device Disconnect



The SG20B disconnects from your base station, and the blue Intermec Ready-to-Work indicator turns off.

**Tip:** Depending on your screen resolution, you may be able to scan bar codes displayed on your computer screen.





# 4

## Configuring the Scanner and Base Station as a System

This chapter explains how to configure the SG20B scanner and SG20 Bluetooth Base Station as a system. It includes these topics:

- **Basic Setup with Configuration Bar Codes**
- **Configuring Your System with EasySet**

## Basic Setup with Configuration Bar Codes

This section provides you with configuration bar codes for a basic setup. For more configuration options, use EasySet (see [“Configuring Your System with EasySet” on page 47](#)).

All default values are marked with (\*).

For a same setup, configuration bar codes can be different depending on whether they apply to the scanner or to the SG20 Bluetooth Base Station. This is indicated in the configuration bar code title (“Scanner” or “Base Station”). For example to reset your scanner to the factory default settings, you will need to scan the “Reset factory defaults - Scanner” configuration bar code; for the base station, scan the “Reset factory defaults - Base station” configuration bar code.



**Note:** It is recommended that your SG20B scanner has established a Bluetooth connection with a SG20 Bluetooth Base Station (see [“Connecting the SG20B Scanner to a SG20 Bluetooth Base Station” on page 34](#)) prior to reading configuration bar codes.

### Reset Factory Defaults

You can reset the factory defaults of the scanner or of the base station.

When resetting your scanner, the Bluetooth connection is lost. Make sure you establish a Bluetooth connection again before trying to read bar codes.

Reset factory defaults - Scanner



Reset factory defaults - Base station



## USB Interface Settings

Use these configuration bar codes to set up your keyboard and USB cable mode.

### International Keyboard

By default the SG20 Bluetooth Base Station uses a North American keyboard layout. Use these configuration bar codes to select the keyboard for your country. Additional keyboards are available in EasySet (see **“Configuring Your System with EasySet” on page 31**).

North American Windows (\*) - Base station



French Windows - Base station



French Canadian Windows 95/98 - Base station



French Canadian Windows XP/2000 - Base station



German Windows - Base station



Spanish Windows - Base station



Italian Windows - Base station



## Chapter 4 – Configuring the Scanner and Base Station as a System

UK English Windows - Base station



Japanese Windows - Base station



Brazilian Portuguese Windows - Base station



Czech Republic Windows - Base station



Slovakian Windows - Base station



Hungarian 101-key - Base station



### USB Cable Mode

By default the USB cable mode is set to keyboard HID. However you can also set up your system to use the virtual COM USB cable mode.

The following configuration bar codes only apply to a connection with the SG20 Bluetooth Base Station when the base station is connected to your host using a USB cable.

USB Keyboard HID (\*)



USB Virtual COM



When you change the USB cable mode, the scanner disconnects from the base station then automatically reconnects to it.

For a first time setup when using the virtual COM USB cable mode you will need to download and install the driver. You can download the driver from Knowledge Central on the Intermec web site.

**To download the USB virtual COM driver:**

- 1 Go to <http://intermec.custhelp.com>.
- 2 In the search box type “SG20B USB driver” and click **Search**.
- 3 Download the driver and instructions.
- 4 Follow the installation procedure provided in Knowledge Central.

After you have installed the driver and set your system to USB Virtual COM mode, open the Intermec Virtual Com Port (for example using EasySet or any terminal emulation program) before scanning bar codes.

## **RS-232 Interface Settings**

Use these configuration bar codes to set up the RS-232 interface.

### **Baud Rate**

38400



57600 (\*)



115200



128000



230400



256000



460800



**Data Bits**

7



8 (\*)



**Parity**

None (\*)



Even



Odd



**Stop Bits**

1 (\*)



2



## Configuring the Postamble

The default postamble is <CR> <LF> for the scanner and None for the base station. For certain applications or when using USB Keyboard HID you may need to change this setting. You can set a postamble for the scanner as well as for the base station.

Data are transmitted as follows with a postamble and/or preamble:

[Preamble - Base station][Preamble - Scanner][Data][Postamble - Scanner][Postamble - Base station].

### Postamble configuration bar codes - Scanner

Use the following configuration bar codes to change the default postamble at scanner level.

Carriage Return + Line Feed (\*) - Scanner



None - Scanner



Carriage Return - Scanner



Enter - Scanner



## **Postamble configuration bar codes - Base Station**

Use the following configuration bar codes to change the default postamble at base station level.

Carriage Return + Line Feed - Base station



None (\*) - Base station



Carriage Return - Base station



Enter - Base station





# Configuring Your System with EasySet

EasySet is an Intermec configuration application that provides you with two ways to configure your scanner.

- Online setup—send configuration commands from EasySet directly to the product.
- Offline setup—send configuration commands to a bar code setup sheet, print the setup sheet and use a scanner to scan the bar codes.

EasySet is available on the Intermec web site at [www.intermec.com/EasySet](http://www.intermec.com/EasySet). Simply download and install.

## Online Setup with EasySet

Online setup with EasySet is only available if you are using an RS-232 cable or a USB cable.

### To configure your system online by sending commands from EasySet

- 1 Connect the base station to a host PC using an RS-232 or USB cable and set connection parameters if necessary.
- 2 Start EasySet. The first time you start EasySet, the **Select product** dialog box appears.  
If the **Select product** dialog box does not appear, choose **Product > Select** or click on the product icon in the upper left corner.
- 3 Select your product (SG20BSYS).
- 4 Select **Communication > Select communication interface**. The **Device Selection** dialog box appears.
- 5 Select the communication interface that you are using for your system and click **OK**.
- 6 EasySet connects to your system and retrieves the current configuration. These configurations are indicated with a blue check mark or blue text. Open the folders to find the configuration commands needed. Double click each command to send it to the system.



**Note:** The scanner does not beep when you send configuration commands online from EasySet. When you select **Disconnect** from the **Communication** menu in Easyset, the base station reboots and the scanner disconnects then reconnects to it.

## **Offline Setup with EasySet**

### **To configure your system offline by scanning bar codes**

- 1** Start EasySet. The first time you start EasySet, the **Select product** dialog box appears.  
If the **Select product** dialog box does not appear, choose **Product > Select** or click on the product icon in the upper left corner.
- 2** Select your product (SG20BSYS).
- 3** Open the folders to find the configuration commands needed. Double-click each command to send each command to the setup sheet.
- 4** Click on the print icon to print out the setup sheet and scan the commands.

# 5

## Connecting and Configuring the SG20B Scanner in Direct Connection

This chapter explains how to connect the SG20B scanner to a host and how to set up the scanner in direct connection configuration. This chapter covers these topics:

- **Connecting the SG20B in Direct Connection**
- **Configuring the SG20B in Direct Connection**

## Connecting the SG20B in Direct Connection

The cordless SG20B scanner can communicate with a host device through the Bluetooth communications Human Interface Device Profile (HID) and Serial Port Profile (SPP).

You can, for example, connect the SG20B scanner to a host PC via an Intermec USB Bluetooth adapter (see **“Intermec USB Bluetooth Adapter” on page 16**). This is called a direct connection as opposed to a connection as a system (which uses an SG20 Bluetooth Base Station to interface with the host).

### HID Bluetooth Device Connection

With the HID profile, your SG20B is recognized as a keyboard. Connection information is stored, meaning that if the scanner loses connection (out of range, low battery, etc.), it will try to reconnect as soon as possible (back into range, charged battery, etc.). Moreover, no specific software is needed in HID profile as opposed to SPP profile to collect data.

Before trying to pair and connect your scanner, make sure:

- it is not already trying to establish a Bluetooth connection. If so, the blue Intermec Ready-to-Work indicator blinks; read the Bluetooth device disconnect bar code.

Bluetooth Device Disconnect



- it is not already paired with your Bluetooth device. If so, remove it from your host’s Bluetooth devices list.
- your host is set to allow Bluetooth device connections.

### Pairing and Connecting as an HID Bluetooth Device

This section describes how to pair and connect your scanner from your host PC.

#### To pair and connect as an HID Bluetooth device

- 1 Turn on your scanner by pulling the trigger.
- 2 Scan the Bluetooth device profile - HID configuration bar code

Bluetooth Device Profile - HID



- 3 Double-click the Bluetooth icon on your taskbar. The Bluetooth Devices listing all paired devices window appears.
- 4 Click on the command for adding a Bluetooth device (**Add** or **Add a device** depending on operating systems). The wizard for adding Bluetooth devices appears.
- 5 Follow the onscreen instructions until your host searches for Bluetooth devices. The SG20B scanner appears in the Bluetooth device list as a keyboard in the following format: SG20B - *BDA*, where *BDA* is the scanner's Bluetooth Device Address.

You can find the BDA on the scanner's label.

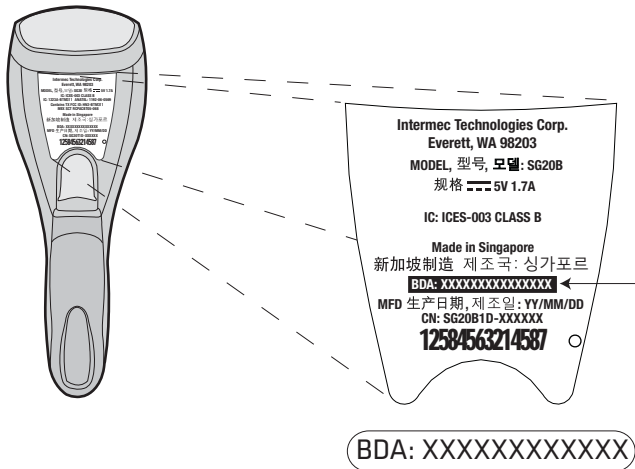

**SG20B BDA:** The scanner BDA can be found on the scanner's label



**Note:** If the scanner does not appear in the list, it might be already paired with the host. Under some operating systems, already paired Bluetooth devices do not appear in the Bluetooth device search list.

- 6 Select your scanner and validate.
- 7 If a PIN is required (depending on your host operating system and Bluetooth version), enter the default Bluetooth PIN (0000) and

validate. The blue Intermec Ready-to-Work indicator starts blinking rapidly, indicating that the scanner is awaiting acknowledgement.

**8** Pull the trigger.

Your scanner automatically connects to the host: it emits a series of beeps from low to high, and the blue Intermec Ready-to-Work indicator turns solid blue.

## **SPP Bluetooth Device Connection**

The SPP profile allows your SG20B to use the Bluetooth link as a serial port to communicate with your host device. If you are using an application working with serial ports, you do not need to modify it to collect data with the SG20B.

You can connect your scanner to your host by initiating the Bluetooth connection either from your SG20B scanner (*incoming* connection) or from your host (*outgoing* connection):

- A scanner-initiated connection requires reading a Bluetooth association bar code then opening the incoming port from an application such as a terminal emulation program.

The advantage of this method is that the scanner automatically tries to reconnect to the host each time the connection is lost.

- A host-initiated connection requires opening the outgoing port from an application such as EasySet or a terminal emulation program.

The advantage of this method is that no Bluetooth association bar code is required but if the connection with the host is lost, you have to follow the connection procedure again.

Before trying to pair or connect your scanner, make sure:

- it is not already trying to establish a Bluetooth connection. If so, the blue Intermec Ready-to-Work indicator blinks; read the Bluetooth device disconnect bar code.

Bluetooth Device Disconnect



- it is not already paired with your Bluetooth device. If so, remove it from your host's Bluetooth devices list or skip the pairing step.
- your host is set to allow Bluetooth device connections.

## **Pairing as an SPP Bluetooth Device**

This section describes how to pair your scanner from your host PC.

### **To pair as an SPP Bluetooth device**

- 1** Turn on your scanner by pulling the trigger.
- 2** Scan the Bluetooth device profile - SPP configuration bar code  
Bluetooth Device Profile - SPP (\*)



- 3** Double-click the Bluetooth icon on your taskbar. The Bluetooth Devices window appears.
- 4** Click on the command for adding a Bluetooth device (**Add** or **Add a device** depending on operating systems). The wizard for adding Bluetooth devices appears.
- 5** Follow the onscreen instructions until your host searches for Bluetooth devices. The SG20B scanner appears in the Bluetooth device list in the following format: SG20B - BDA, where BDA is the scanner's Bluetooth Device Address.

You can find the BDA on the scanner's label.

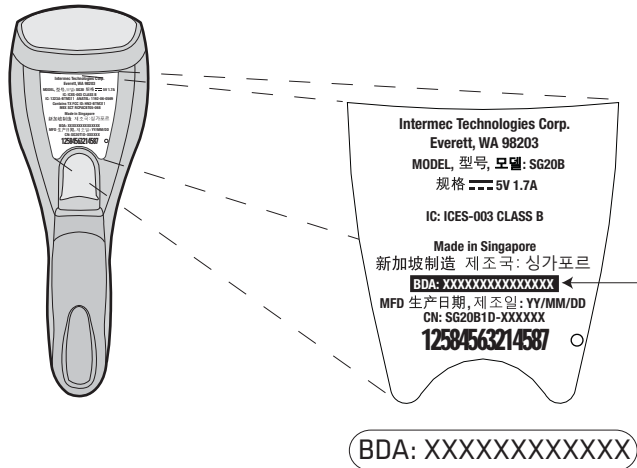

**SG20B BDA:** The scanner BDA can be found on the scanner's label



**Note:** If the scanner does not appear in the list, it might be already paired with the host. Under some operating systems, paired devices do not appear in the Bluetooth device search list.

- 6 Select your scanner and validate.
- 7 If a PIN is required (depending on your host operating system and Bluetooth version), enter the default Bluetooth PIN (0000) and validate. The blue Intermec Ready-to-Work indicator starts blinking rapidly, indicating that the scanner is awaiting acknowledgement.
- 8 Pull the trigger.  
Your scanner is now paired with your host. Two virtual Standard serial ports over Bluetooth link (incoming and outgoing) are created.
- 9 Note the **COM** port numbers and port type (incoming, outgoing) for example by opening the Bluetooth settings from the Bluetooth icon in the taskbar or the operating system **Device Manager**.



## **Connecting from your Host as an SPP Bluetooth Device**

This section describes how to connect your scanner from your host.

### **To connect from the host**

- 1** Once your scanner is paired with your host, turn it on by pulling the trigger. Make sure it is set as an SPP Bluetooth device.
- 2** Start EasySet version 5.6.5.1 or later. Make sure that SG20B is selected as your product.
- 3** Select **Communication > Select communication interface**. The Device Selection dialog box appears.
- 4** Select the outgoing COM port (Standard Serial over Bluetooth link) that you noted at the end of the pairing procedure and click **OK**.
- 5** Depending on the time elapsed since your last connection or if your scanner has been reset since pairing, a pop-up might appear, indicating that a Bluetooth device is trying to connect.
- 6** If so, click on the pop-up. A window appears asking for the pairing code. Enter the default Bluetooth PIN (0000) and validate.

When the scanner connects to your host PC, it emits a series of beeps from low to high, and the blue Intermec Ready-to-Work indicator turns solid blue.

- 7** To disconnect from EasySet, select **Communication > Disconnect**.

When the scanner disconnects from your host PC, it emits a series of beeps from high to low, and the blue Intermec Ready-to-Work indicator turns off.



**Note:** You can also connect your scanner to your host from any terminal emulation program by opening the required port.

## Connecting from your Scanner as an SPP Bluetooth Device

This section describes how to connect your scanner from your scanner.

### To connect from the scanner

- 1 Once your scanner is paired, turn it on by pulling the trigger. Make sure it is set as an SPP Bluetooth device.
- 2 Start EasySet version 5.6.5.1 or later. Make sure that SG20B is selected as your product.
- 3 Select the **Interface > Bluetooth > Connect/disconnect** folder.
- 4 Double-click on the **Compose BT address** command. A **Bluetooth - Connect/disconnect - Compose BT address** window opens.
- 5 Compose your host Bluetooth Device Address (BDA) and click **OK**. The Bluetooth association bar code is created.
- 6 Print and read the Bluetooth association bar code. The blue Intermec Ready-to-Work starts blinking.
- 7 Open the incoming port that you noted at the end of the pairing procedure, for example from a terminal emulation program.  
  
When the scanner connects to your host PC, it emits a series of beeps from low to high, and the blue Intermec Ready-to-Work indicator turns solid blue.
- 8 To disconnect, close the incoming port.  
  
When the scanner disconnects from your host PC, it emits a series of beeps from high to low, and the blue Intermec Ready-to-Work indicator turns off. The LED starts blinking.

## Connectivity Matrix

A connectivity matrix listing all Bluetooth devices the SG20B scanner can connect to is available. You can download it from Knowledge Central on the Intermec web site.

### To download the connectivity matrix

- 1 Go to <http://intermec.custhelp.com>.
- 2 In the search box type SG20B and click **Search**.

- 3 Select the Connectivity Matrix in the list.

## Configuring the SG20B in Direct Connection

This section provides you with configuration bar codes for a basic setup of your scanner. It also gives the procedure for configuring your scanner in direct connection using EasySet.

### Basic Setup with Configuration Bar Codes

These configuration bar codes apply when your scanner is connected to a host in direct connection only.

All default values are marked with (\*).

#### Resetting Your Scanner

To reset your scanner, read the reset factory defaults configuration bar code.

Reset factory defaults



#### Setting an International Keyboard

By default the SG20B uses a North American keyboard layout. Use these configuration bar codes to select the keyboard for your country. Additional keyboards are available in EasySet (see “[Configuring Your System with EasySet](#)” on page 31).

North American Windows (\*)



French Windows



French Canadian Windows 95/98



**Chapter 5 – Connecting and Configuring the SG20B Scanner in Direct Connection**

French Canadian Windows XP/2000



German Windows



Spanish Windows



Italian Windows



UK English Windows



Japanese Windows



Brazilian Portuguese Windows



Czech Republic Windows



Slovakian Windows



Hungarian 101-key



**Configuring the Postamble**

The default postamble is <CR> <LF>. For certain applications or when using your scanner as an HID Bluetooth device you may need to change this setting. Use the following configuration bar codes to change the default postamble in your scanner.

Carriage Return + Line Feed (\*)



None



Carriage Return



Enter



## Configuring Your Scanner with EasySet in Direct Connection

EasySet is an Intermec configuration application that provides you with two ways to configure your scanner.

- Online setup—send configuration commands from EasySet directly to the product.
- Offline setup—send configuration commands to a bar code setup sheet, print the setup sheet and use a connected scanner to scan the bar codes.

EasySet is available on the Intermec web site at [www.intermec.com/EasySet](http://www.intermec.com/EasySet). Simply download and install.

### Online Setup with EasySet

Online setup with EasySet is available in direct connection if you are using your scanner either as an SPP or as an HID Bluetooth device.

#### To configure your scanner online by sending commands from EasySet

- 1 Connect the scanner to a host PC (see “[Connecting the SG20B in Direct Connection](#)” on page 50).
- 2 Start EasySet. The first time you start EasySet, the Select product dialog box appears.  
  
If the Select product dialog box does not appear, choose **Product > Select** or click on the product icon in the upper left corner.
- 3 Select your product (SG20B).
- 4 Select **Communication > Select communication interface**. The Device Selection dialog box appears.
- 5 Select the communication interface that you are using for your scanner and click **OK**.
- 6 EasySet connects to your scanner and retrieves the current configuration. These configurations are indicated with a blue check mark or blue text. Open the folders to find the configuration commands needed. Double click each command to send it to the scanner.



**Note:** The scanner does not beep when you send configuration commands online from EasySet. It powers off when you select **Disconnect** from the **Communication** menu in Easyset.

## **Offline Setup with EasySet**

### **To configure your scanner offline by scanning bar codes**

- 1** Start EasySet. The first time you start EasySet, the Select product dialog box appears.  
If the Select product dialog box does not appear, choose **Product > Select** or click on the product icon in the upper left corner.
- 2** Select your product (SG20B).
- 3** Open the folders to find the configuration commands needed.  
Double-click each command to send each command to the setup sheet.

Click on the print icon to print out the setup sheet and scan the commands.





# 6

## Troubleshooting and Maintaining the Scanner and Base Station

Use this chapter to solve problems you may have while using the SG20B and SG20 Bluetooth Base Station. This chapter contains these topics:

- **Troubleshooting the SG20B and SG20 Bluetooth Base Station**
- **Maintaining the SG20B and S20 Bluetooth Base Station**

# Troubleshooting the SG20B and SG20 Bluetooth Base Station

If you have problems using the SG20B or the SG20 Bluetooth Base Station, use this chapter to find a possible solution.

## Calling Product Support

To talk to an Intermec Product Support representative:

- In the U.S.A. and Canada, call **1-800-755-5505**
- Outside the U.S.A. and Canada, contact your local Intermec representative. For help, go to [www.intermec.com](http://www.intermec.com) > **About Us** > **Contact Us**.

Before you call Intermec Product Support, make sure you have the following information:

- SG20B and/or SG20 Bluetooth Base Station firmware version
- SG20B decode version

### To get the firmware version and decode version

- 1 Run an application that can accept bar code information from the SG20B:
  - If you are using a USB Keyboard HID or keyboard wedge interface for your SG20 Bluetooth Base Station or if your SG20B scanner is connected to a Bluetooth device with the HID Bluetooth profile, use Microsoft® Notepad.
  - If you are using an RS-232 or USB Virtual Com interface for your SG20 Bluetooth Base Station or if your SG20B scanner is connected to a Bluetooth device with the SPP Bluetooth profile, use the EasySet ISCP Terminal window (see [“Configuring Your System with EasySet” on page 47](#)).

- 2 Scan one of these bar codes:

Get firmware version - Scanner



Get decode version - Scanner



Get firmware version - Base station



## Problems and Possible Solutions

Use this section to find possible solutions to problems you may have.

### **Problems and Possible Solutions**

<b>Problem</b>	<b>Possible Solution</b>
You pull the trigger, but nothing happens.	<p>The SG20B is powered by a rechargeable lithium-ion battery. Make sure the battery is not fully discharged.</p> <p>To recharge your SG20B scanner, dock it in a properly powered SG20B Charge Base or SG20 Bluetooth Base Station (see <b>“SG20 Bluetooth Base Station Recommended Connections” on page 23</b>).</p>
You pull the trigger, the red scanning beam (1D) or laser framing (2D) turns on, but you cannot successfully scan a bar code.	<p>Try these possible solutions:</p> <ul style="list-style-type: none"><li>• Make sure that the SG20B is configured for the symbology you are scanning.</li><li>• Make sure that the SG20B is at the appropriate scanning distance from the bar code. Move the SG20B closer and farther away to find the appropriate distance.</li><li>• Make sure that the SG20B is configured for the type (1D, 2D) of bar code you are scanning.</li><li>• Make sure the bar code you are trying to scan is not poorly printed or too small. Scan a known good bar code to make sure that the SG20B is working properly.</li></ul> <p>For more information, see <b>“Scanning Bar Codes” on page 7</b>.</p>

**Problems and Possible Solutions (continued)**

Problem	Possible Solution
You scan a bar code and the status light turns on, but the SG20B does not beep.	The beep duration, volume, frequency, and number may be configured so the SG20B does not beep. To reset the SG20B, scan this bar code:  Reset factory defaults - Scanner  
You scan a (configuration) bar code and the SG20B beeps six very fast beeps.	The SG20B does not recognize or support the configuration bar code you scanned, or has lost connection with your host (out of range, low battery...).  Try to re-establish the Bluetooth connection with the SG20 Bluetooth Base Station (see <b>“Connecting the SG20B Scanner to a SG20 Bluetooth Base Station” on page 34</b> ) or host Bluetooth interface (see <b>“Connecting the SG20B Scanner in Direct Connection to a Host” on page 51</b> ) by getting back into range or recharging your scanner.
You scan a bar code, the SG20B beeps once, and the status light blinks green once, but the data is not transmitted to the host computer.	Try these possible solutions: <ul style="list-style-type: none"><li>• Make sure that your data collection application is set up to receive data from the SG20B.</li><li>• If you are using an SG20 Bluetooth Base Station connected to your host using an RS-232 cable, make sure that the serial parameters on the SG20B match the serial parameters of the host computer. The default serial parameters for the SG20B are: 57600 baud, 8 data bits, no parity, and 1 stop bit.</li></ul>
You cannot establish a direct Bluetooth connection with your scanner.	There might be a problem with your host Bluetooth interface. Try disabling then enabling your host Bluetooth radio from the <b>Device Manager</b> , or unplugging then plugging again the Intermec USB Bluetooth Adapter, if applicable.

**Problems and Possible Solutions (continued)**

<b>Problem</b>	<b>Possible Solution</b>
You cannot charge your scanner or establish a Bluetooth connection with the SG20 Bluetooth Base Station.	There might be a problem with your base station connection. This is indicated by a blinking of the SG20 Bluetooth Base Station blue Intermec Ready-to-Work indicator. Make sure the SG20 Bluetooth Base Station is properly connected to your host (see <b>“SG20 Bluetooth Base Station Recommended Connections” on page 23</b> ).
Your scanner is unresponsive.	Try to reset it electrically by pushing the reset button (see <b>“Resetting the SG20B Scanner” on page 81</b> ).
You cannot scan the Firmware upgrade bar code on your computer screen.	Print out this bar code and scan it: Firmware upgrade 

# Maintaining the SG20B and S20 Bluetooth Base Station

To keep your SG20B in good working order, you may need to upgrade the SG20B firmware and clean the scanner window. Should you encounter any unresponsiveness or battery fault problem, you can electrically reset the scanner and change the battery if need be.

This section also describes how to upgrade the SG20 Bluetooth Base Station firmware.

## Upgrading the SG20B

You may need to upgrade the SG20B firmware if there is an update that incorporates changes to a feature or adds functionality to the scanner. When you upgrade your scanner the current settings are erased and replaced with the default settings. The process of upgrading the SG20B takes about 20 minutes to complete.

To upgrade the SG20B you need:

- Bluetooth interface such as an Intermec USB Bluetooth Adapter (see **“Intermec USB Bluetooth Adapter” on page 16**) or an internal Bluetooth controller.
- Minimum PC operating system requirements are Microsoft® Windows® XP with SP2 or Microsoft Windows 2000 with SP4 or higher versions.
- EasySet version 5.6.5.1 (see **“Configuring Your System with EasySet” on page 47**) or later with WinFlash.
- The firmware update file (.bin).



**Note:** Before you start the upgrade process, make sure that you are not using the selected COM port for any other application or you receive an error and cannot use the COM port.

Your scanner can be paired or not with your host prior to upgrading it. The following procedures cover both cases.

**To upgrade the SG20B firmware when your scanner is already paired with your host**

- 1** Download the latest SG20B firmware update package from the Intermec web site at [www.intermec.com](http://www.intermec.com).
  - a** Go to **Support > Downloads**.
  - b** From the **Product Category** drop-down list, choose **Bar Code Scanners**.
  - c** From the **Product Family** drop-down list, choose **Wireless**.
  - d** From the **Product** drop-down list, choose **SG20B** and click **Submit**.
  - e** Click the link to download the firmware upgrade package and save firmware upgrade file (.bin) to your PC.
- 2** If your scanner is connected to your host, disconnect it by reading the Bluetooth Device Disconnect bar code.

Bluetooth Device Disconnect



- 3** If your host outgoing port is open, close it.
- 4** If your scanner is paired as an HID Bluetooth device, remove it from your host Bluetooth devices and follow the procedure for upgrading an unpaired scanner (see **“To upgrade the SG20B firmware when your scanner is not paired with your host” on page 72**).
- 5** Scan the Firmware Upgrade bar code:

Firmware upgrade



- 6** Start EasySet version 5.6.5.1 or later. Make sure SG20B is selected as your product.
- 7** From the **Tools** menu, select **Upgrade product firmware** to start WinFlash.

## Chapter 6 – Troubleshooting and Maintaining the Scanner and Base Station

- 8 If WinFlash is not already installed or if a more recent version is available you will be asked to install it. Click **Yes** and follow the installation instructions. After installing WinFlash, start WinFlash from the **Tools** menu, select **Upgrade product firmware**.
- 9 Select SG20B 1D scanner or SG20B 2D scanner and click **Next**.

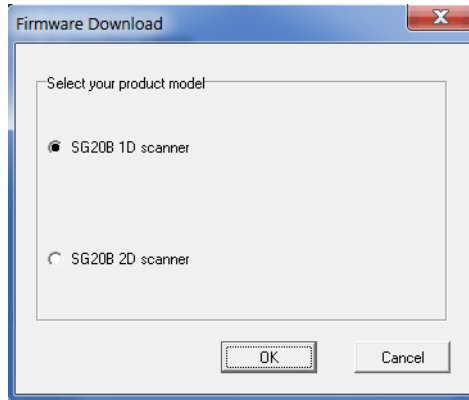

- 10 Use **Browse** to browse to the location of the firmware upgrade file (.bin), select the file, and click **Open**. Click **Next**.

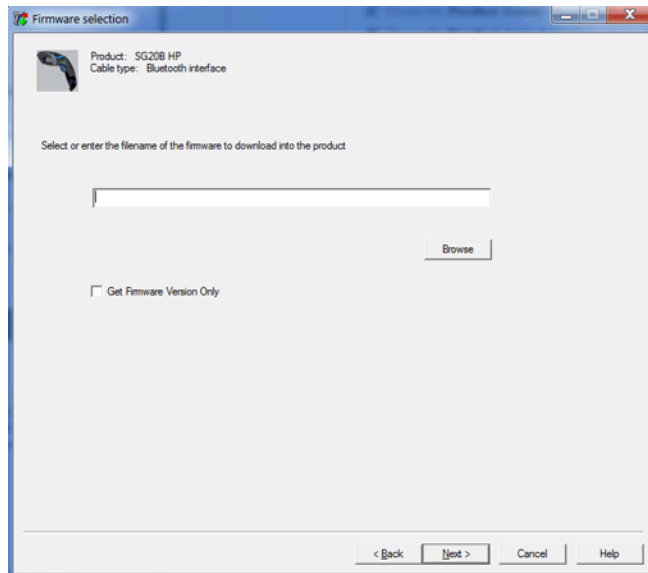



**11** Click **OK** when the Firmware upgrade bar code appears.

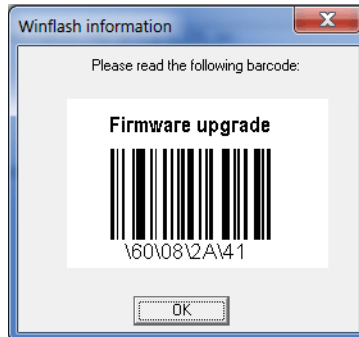

**12** Select the outgoing Com port. Click **Next**.

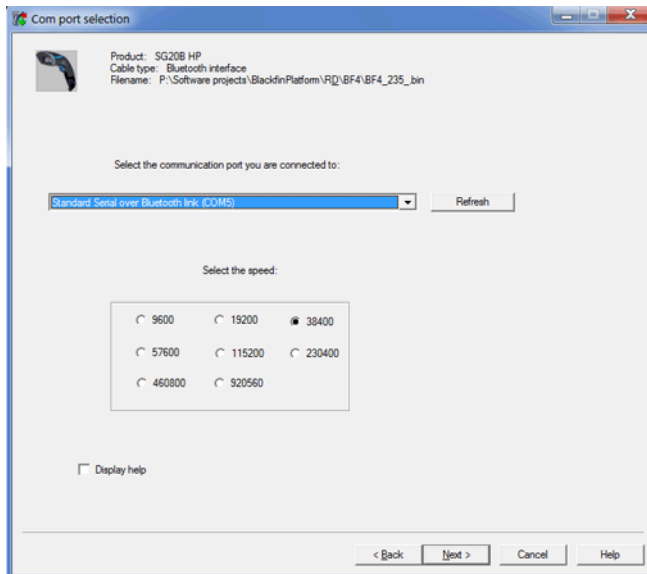

**Note:** To know which port is the outgoing port, check in the Bluetooth option settings or in **Windows Configuration Panel**, in the **Device Manager** > **Ports** section.

**13** Click **Start download**.

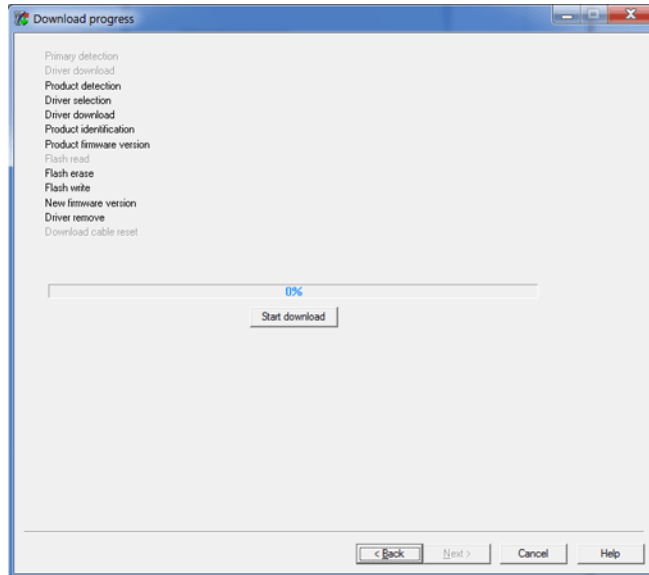

When the firmware download is complete, the “Operation successful” message appears.

**14** Click **Finish**. You have successfully upgraded your scanner firmware.



**Note:** If the firmware download is not successful, you must restart the firmware download procedure.

**To upgrade the SG20B firmware when your scanner is not paired with your host**

- 1** Download the latest SG20B firmware update package from the Intermec web site at [www.intermec.com](http://www.intermec.com).
  - a** Go to **Support > Downloads**.
  - b** From the **Product Category** drop-down list, choose **Bar Code Scanners**.
  - c** From the **Product Family** drop-down list, choose **Wireless**.

## Chapter 6 – Troubleshooting and Maintaining the Scanner and Base Station

- d From the **Product** drop-down list, choose **TBD** and click **Submit**.
  - e Click the link to download the firmware upgrade package and save firmware upgrade file (.bin) to your PC.
- 2 Scan the Firmware Upgrade bar code:

Firmware upgrade



- 3 Pair your scanner as an SPP Bluetooth device (see **“Connecting your SG20B as an SPP Bluetooth Device” on page 56**).



**Note:** After reading the Firmware Upgrade bar code, your scanner cannot be turned on by pressing the trigger. Follow the pairing procedure anyway without turning on your scanner.

- 4 Unlike the normal pairing procedure, when upgrading it your scanner does not have to be responsive to be paired with your host.
- 5 Start EasySet version 5.6.5.1 or later. Make sure SG20B is selected as your product.
- 6 From the **Tools** menu, select **Upgrade product firmware** to start WinFlash.
- 7 If WinFlash is not already installed or if a more recent version is available you will be asked to install it. Click **Yes** and follow the installation instructions. After installing Winflash, start WinFlash from the **Tools** menu, select **Upgrade product firmware**.

- 8** Select SG20B 1D scanner or SG20B 2D scanner and click **Next**.

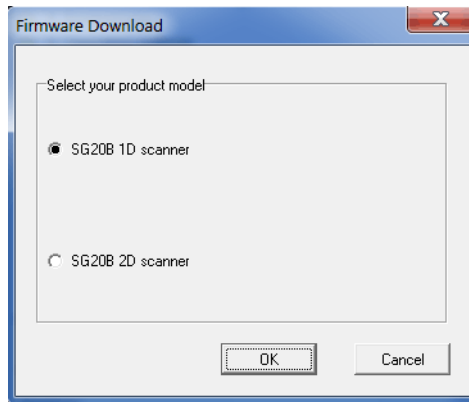

- 9** Use **Browse** to browse to the location of the firmware upgrade file (.bin), select the file, and click **Open**. Click **Next**.

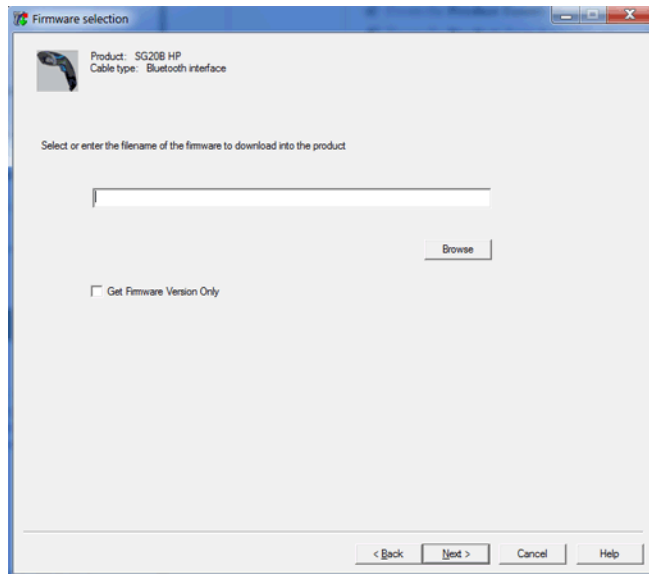

**10** Click **OK** when the Firmware upgrade bar code appears.

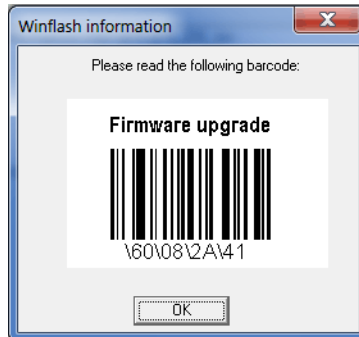

**11** Select the outgoing Com port. Click **Next**.

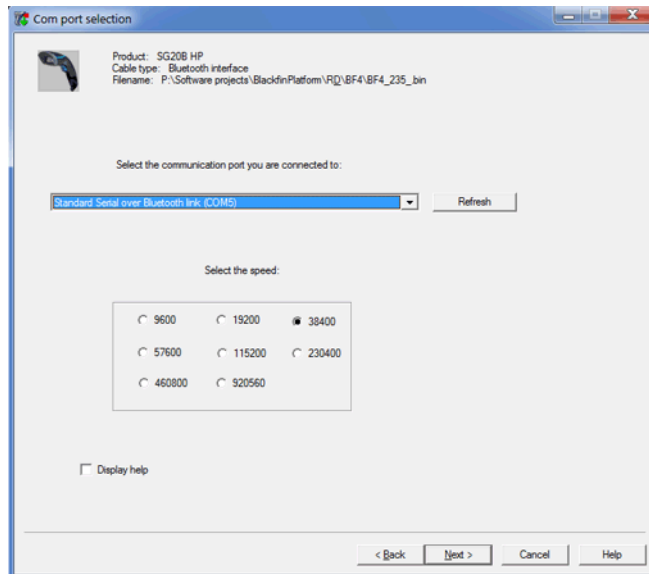

**Note:** To know which port is the outgoing port, check in the Bluetooth option settings or in **Windows Configuration Panel**, in the **Device Manager** > **Ports** section.

**12** Click **Start download**.

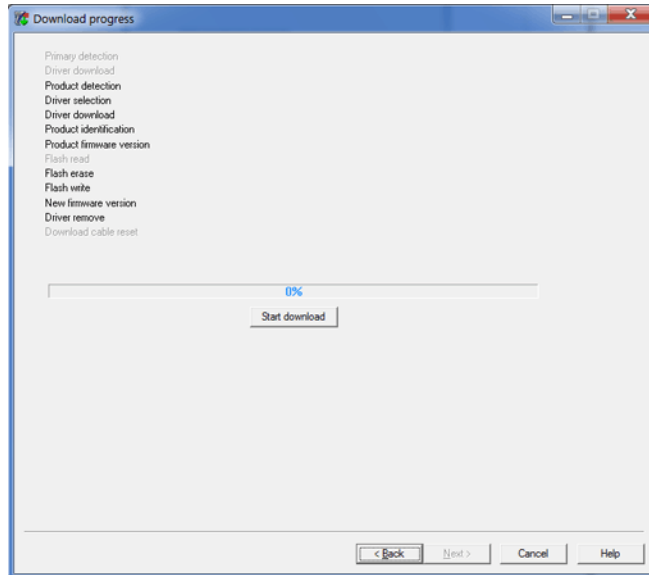

When the firmware download is complete, the “Operation successful” message appears.

**13** Click **Finish**. You have successfully upgraded your scanner firmware.



**Note:** If the firmware download is not successful, you must restart the firmware download procedure.

## Upgrading the SG20 Bluetooth Base Station

You may need to upgrade the SG20 Bluetooth Base Station if there is an update that incorporates changes to a feature or adds functionality to the base station. When you upgrade your base station the current settings are erased and replaced with the default settings. The process of upgrading the SG20 Bluetooth Base Station takes less than 5 minutes to complete.

To upgrade the SG20 Bluetooth Base Station you need:

- A powered RS-232 cable. For more information on cables, see [“Accessories” on page 25](#).

## Chapter 6 – Troubleshooting and Maintaining the Scanner and Base Station

- Minimum PC operating system requirements are Microsoft® Windows® XP with SP2 or Microsoft Windows 2000 with SP4 or higher versions.
- EasySet version 5.6.5.1 or later.
- The firmware update file (.bin).



**Note:** Before you start the upgrade process, make sure that you are not using the selected COM port for any other application or you receive an error and cannot use the COM port.

### To upgrade the SG20 Bluetooth Base Station firmware

- 1** Download the latest SG20 Bluetooth Base Station firmware update package from the Intermec web site at [www.intermec.com](http://www.intermec.com).
  - a** Go to **Support > Downloads**.
  - b** From the **Product Category** drop-down list, choose **Bar Code Scanners**.
  - c** From the **Product Family** drop-down list, choose **Wireless**.
  - d** From the **Product** drop-down list, choose **TBD** and click **Submit**.
  - e** Click the link to download the firmware upgrade package and save firmware upgrade file (.bin) to your PC.
- 2** Connect your SG20 Bluetooth Base Station to a host PC with the RS-232 cable.
- 3** Start EasySet version 5.6.5.1 or later. Make sure that SG20BSYS is selected as your product.
- 4** From the **Tools** menu, select **Upgrade product firmware** to start WinFlash.
- 5** If WinFlash is not already installed or if a more recent version is available you will be asked to install it. Click **Yes** and follow the installation instructions. After installing Winflash, start WinFlash from the **Tools** menu, select **Upgrade product firmware**.

**6** Select the RS-232 cable and click **Next**.

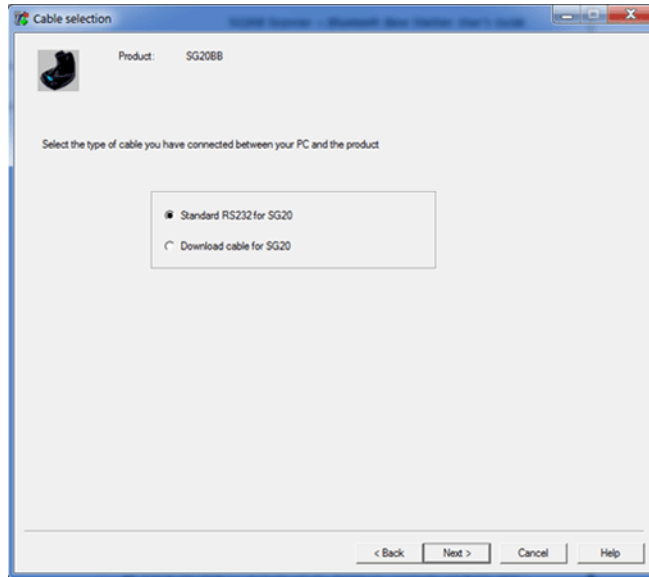

**7** Use **Browse** to browse to the location of the firmware upgrade file (.bin), select the file, and click **Open**. Click **Next**.

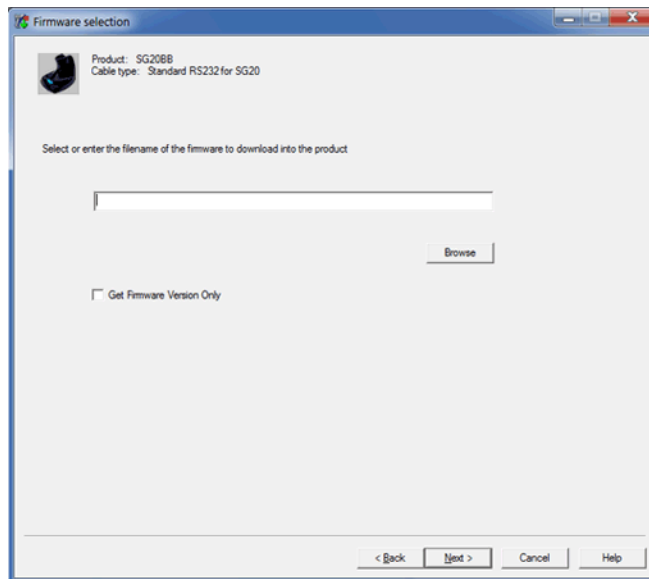



**8** Select the Com port and parameters. Click **Next**.

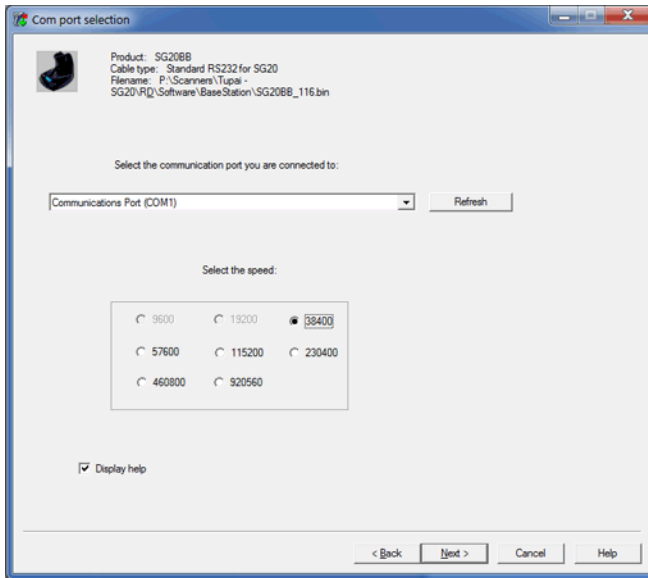

**9** Click **Start download**.

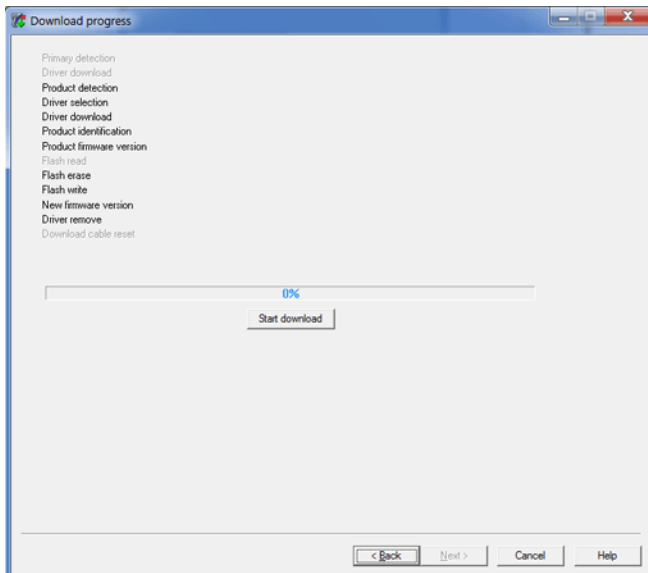

When the firmware download is complete, the “Operation successful” message appears.

- 10 Click **Finish**. You have successfully upgraded your SG20 Bluetooth Base Station firmware.



**Note:** If the firmware download is not successful, you must restart the firmware download procedure.

## Scanner Recovery

If something happens to your scanner and it does not turn on despite using the correct cables and power supply, the only way to recover the scanner is to reinstall the firmware. This is only possible when using the download cable (see “**Required Accessories**” on page 13). Follow the instructions for upgrading the firmware in this chapter.

## Cleaning the SG20B

Clean the scanner window as often as needed for the environment in which you are using the SG20B. To clean the scanner window, you can use soapy water, a solution of ammonia and water, or isopropyl alcohol.



Caution

**Opening the SG20B may cause damage to the internal components.**

### To clean the scanner window

- 1 Dip a clean towel or rag in soapy water, ammonia and water solution, or isopropyl alcohol and wring out the excess. Wipe the scanner window. Do not allow any abrasive material to touch the window.
- 2 Wipe dry with a lint-free cloth.

## Resetting the SG20B Scanner

If your scanner becomes unresponsive, you can manually reset it by inserting a pin in the reset hole and pushing the reset button.

After a manual reset, your scanner is still configured as it was before, current parameters are not reset.

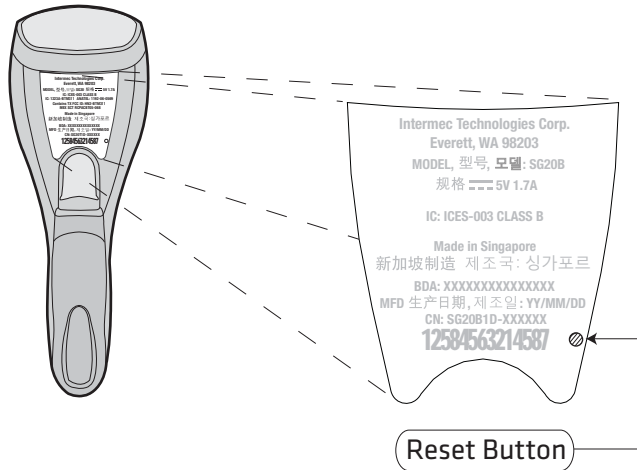

## Replacing the SG20B Scanner Battery

If your scanner flashes a battery fault signal (blinking amber LED), you can order a new battery pack (P/N BP-SG20-xxx) and replace the defective battery by the new one.

Always fully charge a new battery in your SG20B scanner before using it. Batteries can be charged after a partial discharge without affecting the original battery capacity. A fully discharged battery charges in approximately 3 hours.

You can charge the battery with one of these accessories:

- SG20B Charge Base (P/N CB-SG20-xxx)
- SG20 Bluetooth Base Station (P/N BB-SG20-xxx)



Integrated circuits on printed circuit boards (PCBs) in this equipment are sensitive to damage by electrostatic discharge (ESD). Prevent ESD by always wearing skin contact ground straps firmly attached to the equipment metal base assembly when working inside of the equipment housing. Failure to comply may result in damage to PCB components.

**To replace the SG20B battery**

- 1 Remove the cap end from the bottom of the SG20B using a pin.

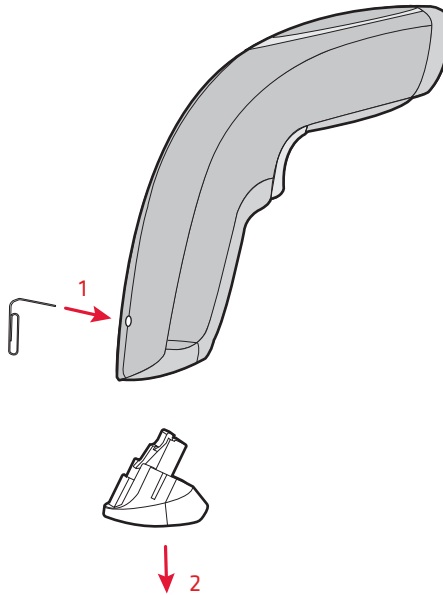

## Chapter 6 – Troubleshooting and Maintaining the Scanner and Base Station

- 2 Loosen and remove the screw holding the upper case.

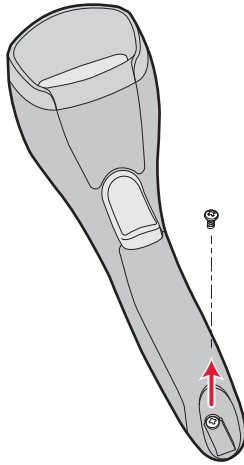

- 3 Slide the upper case back and remove it.

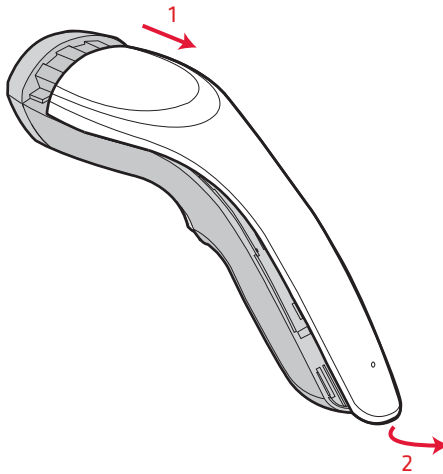

## Chapter 6 – Troubleshooting and Maintaining the Scanner and Base Station

- 4 Hold the PCB firmly so it does not bend while you disconnect the battery cable and remove the battery.

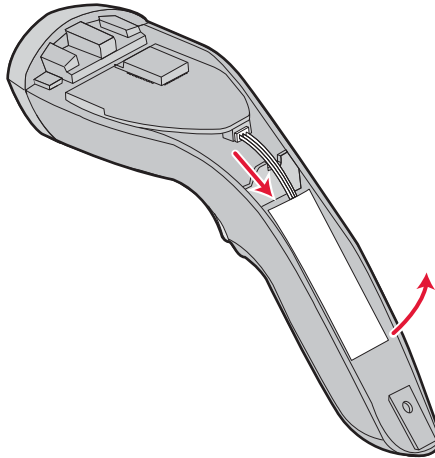

- 5 Install the new battery.
- 6 Place the battery in its compartment and connect the battery cable.
- 7 Make sure cables are properly passed through the notch so they are not pinched and cut while you slide the upper case back in place.

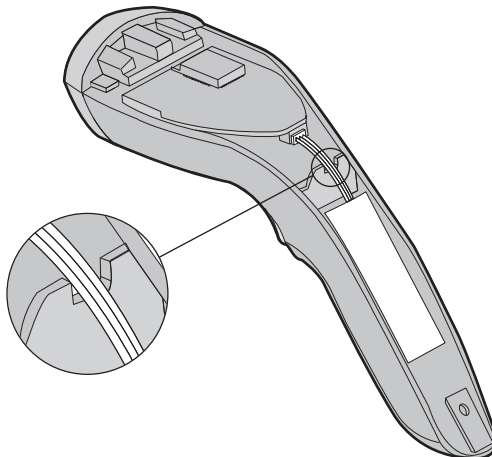

- 8 Install the upper case screw, tighten to 0.68 Nm (6 in-lb) and clip the cap end back into the scanner.

# A

## Specifications and Reading Distances

This appendix contains the technical specifications of the scanner and base station as well as reading distances for each scanner model.

# Scanner Specifications

Use this section to find technical information about the cordless SG20B scanner.

## Physical Dimensions

Length	20.3 cm (8 in)
Height	6.5 cm (2.6 in)
Width	6.1 cm (2.4 in)
Weight	175 g (6.2 oz)

## Power and Electrical Specifications

Operating	Rechargeable lithium-ion battery (1567 mAh)
Electrical rating	≡ 5V, 1.7 A

## Temperature and Environmental Specifications

Operating temperature	0°C to 50°C (32°F to 122°F)
Storage temperature	-20°C to 60°C (-4°F to 140°F)
Relative humidity	5 to 95% non-condensing
Shock	30 G, 11 ms half-sine, 3 directions
Vibrations	8G, from 10Hz to 500Hz, 2hr/axis, 3 axes
Environmental rating	IP30
Ambient light	0 to 100 000 lux
Artificial light	25 000 lux



**Scanning Performance**

SG20B1D	Scan angle: 38° Minimum X dimension: 6 mils (0.15 mm)
SG20BHP, SG20BHPHC	Scan angles: 34.4° horizontal, 22.2° vertical Framing angles: 30° horizontal, 20° vertical Min. X dimension 1D: 4 mils (0.1 mm) Min. X dimension 2D: 6.6 mils (0.17 mm)

**Bluetooth Radio**

Radio Type	Bluetooth Class 2 version 2.1 + EDR
Frequency	2400 - 2483.5 MHz
Radio Data Rate	2 Mbits/s

**Communication Range**

Host radio Class 2	10 m (32.8 ft)
Features	Adaptive Frequency Hopping (AFH)

**Bar Code Symbolologies for 2D Models (SG20BHP, SG20BHPHC)**

Australian Post	Infomail
Aztec	Intelligent mail
BPO	Interleaved 2 of 5
Canada Post	Japan Post
Codabar	Matrix 2 of 5
Codablock A	Maxicode
Codablock F	Micro PDF417
Code 11	MSI
Code 39	Multicode
Code 93/93i	PDF417
Code 128 / GS1-128	Planet

## Appendix A – Specifications and Reading Distances

### Bar Code Symbologies for 2D Models (SG20BHP, SG20BPHC) (continued)

DataMatrix	Plessey
Dutch Post	Postnet
EAN/UPC	QR Code
GS1 Composite (linear only)	Standard 2 of 5
GS1 DataBar Expanded	Sweden Post
GS1 DataBar Limited	Telepen
GS1 DataBar Omni-Directional	TLC 39
GS1 DataBar Stacked	

### Bar Code Symbologies for 1D Model (SG20B1D)

Codabar	GS1 DataBar Limited
Code 11	GS1 DataBar Omni-Directional
Code 39	Interleaved 2 of 5
Code 93/93i	Matrix 2 of 5
Code 128 / GS1-128	MSI
EAN/UPC	Plessey
GS1 Composite	Standard 2 of 5
GS1 DataBar Expanded	Telepen

# Base Station Specifications

Use this section to find technical information about the SG20 Bluetooth Base Station.

## Physical Dimensions

Length	13.1 cm (5.2 in)
Height	9.9 cm (3.9 in)
Width	10.6 cm (4.2 in)
Weight	280 g (9.88 oz)

## Interfaces

RS-232, USB (HID and VCP), Keyboard Wedge

## Electrical Specifications

Operating voltage	$\pm 5V \pm 10\%$
Operating current	90 mA
Maximum current (fully discharged scanner)	USB = 0.5 A @ 5 V RS-232 = 1.2 A @ 5 V

## Temperature and Environmental Specifications

Operating temperature	0°C to 50°C (32°F to 122°F)
Operating temperature (when charging)	0°C to 40°C (32°F to 104°F)
Storage temperature	-20°C to 60°C (-4°F to 140°F)
Relative humidity	5 to 95% non-condensing
Shock	30 G, 11 ms half-sine, 3 directions
Vibrations	8G, from 10Hz to 500Hz, 2hr/axis, 3 axes

**Bluetooth Radio**

Radio Type	Bluetooth Class 2 version 2.1 + EDR
Frequency	2400 - 2483.5 MHz

**Certifications**

UL, cUL, FCC, IP30

## **Reading Distances**

The reading distances for each scanner are typical distances measured from the front end of the scanner bezel in an office environment (200 lux).

# SG20B1D

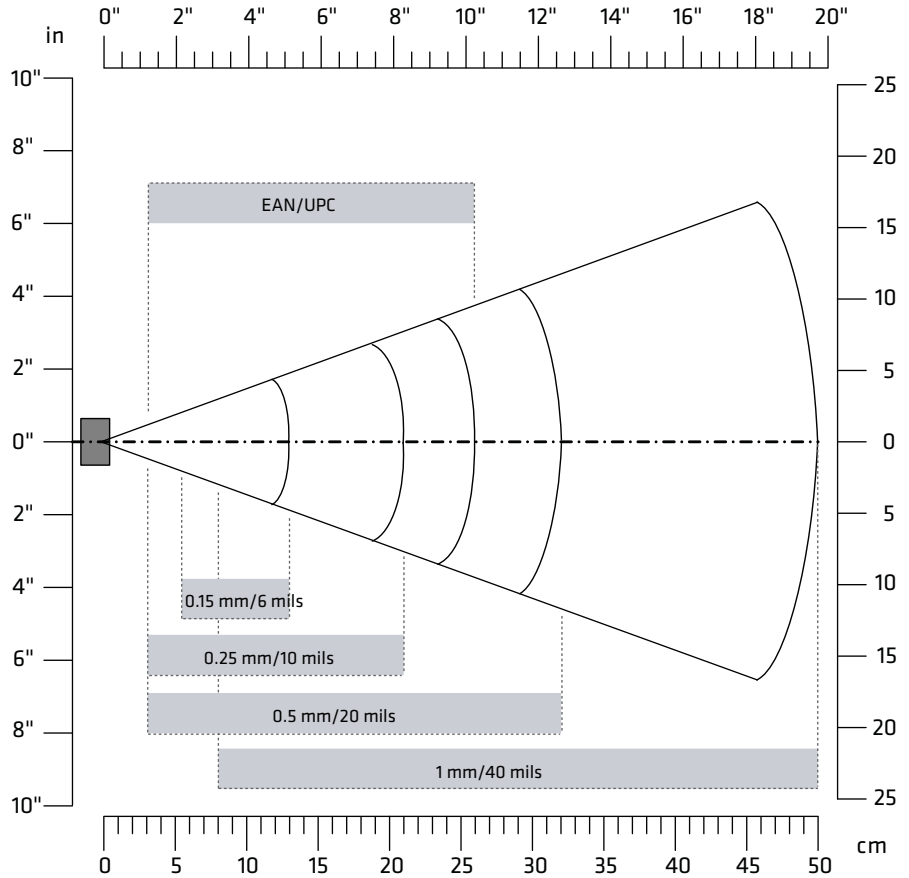

Symbology	Density	Minimum Distance	Maximum Distance
Code 39	0.15 mm (6 mils)	6 cm (2.36 in)	13 cm (5.12 in)
	0.25 mm (10 mils)	3 cm (1.18 in)	21 cm (8.26 in)
	0.5 mm (20 mils)	3 cm (1.18 in)	32 cm (12.6 in)
	1 mm (40 mils)	8 cm (3.15 in)	50 cm (19.68 in)
EAN/UPC	0.33 mm (13 mils)	3 cm (1.18 in)	26 cm (10.24 in)

# SG20BHP, SG20BHPHC

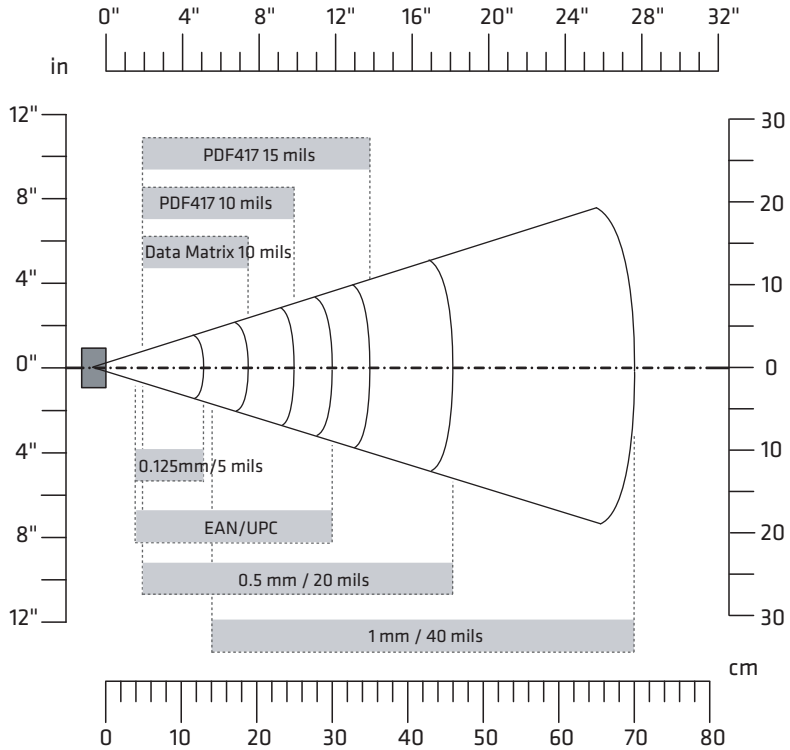

Symbology	Density	Minimum Distance	Maximum Distance
Code 39	0.125 mm (5 mils)	4 cm (1.57 in)	12.5 cm (4.92 in)
	0.5 mm (20 mils)	5 cm (1.97 in)	46 cm (18.11 in)
	1 mm (40 mils)	12 cm (4.72 in)	70 cm (27.56 in)
EAN/UPC	0.33 mm (13 mils)	4 cm (1.57 in)	30 cm (11.8 in)
PDF417	0.25 mm (10 mils)	3 cm (1.18 in)	25 cm (9.84 in)
	0.38 (15 mils)	3 cm (1.18 in)	35 cm (13.78 in)
DataMatrix	.025 mm (10 mils)	3 cm (1.18 in)	19 cm (7.48 in)

# B

## Optimizing Scanner Performance

This appendix provides a selection of configuration bar codes that may help to optimize decoding in specific situations and environments. You will also find in this appendix bar codes for hands-free scanning.

All default values are marked with (\*).

## Optimizing Decoding

Use the following barcodes to optimize your scanner reading performance.



**Note:** These configuration bar codes are only for the SG20BHP and SG20BHPHC models.

### Damaged 1-Dimensional Bar Codes

If you are reading 1D bar codes that are damaged or badly printed, enable this setting to enhance the ability to read these types of bar codes.

Damaged 1D Codes - Enable



Damaged 1D Codes - Disable (\*)



### Predefined Imager Modes

When using a 2D model (SG20BHP or SG20BHPHC), you can optimize the reading performance of the scanner by adjusting certain parameters. Since there are many parameters that can be adjusted, we recommend using the pre-defined imager settings to quickly set up your imager for optimized reading. The pre-defined imager settings take in to account the type of bar code, environment and reading surface.

There are 4 pre-defined imager settings:

- 1-Dimensional bar codes only
- Standard 1-dimensional and 2-dimensional bar codes
- 1-Dimensional and 2-dimensional bar codes in a bright environment
- 1-Dimensional and 2-dimensional bar codes with reflective surface (shiny labels)



Select the pre-defined imager setting that best suits your needs:

1D bar codes only



Standard 1D and 2D bar codes (\*)



Standard 1D and 2D bar codes, bright environment



Standard 1D and 2D bar codes, reflective surface



## **DPM Mode**

Direct Product Marking (DPM) is when the bar code is marked directly on the product. Enabling DPM Mode when scanning DPM bar codes optimizes reading this type of code.

DPM mode - Enable



DPM mode - Disable (\*)



**Note:** DPM mode is not required to be able to read DPM bar codes but may be necessary when scanning hard to read DPM bar codes.

## Hands-Free Scanning

For hands-free scanning as explained in **“Hands-Free Scanning”** on **page 9** activate Autostand triggering mode by scanning this configuration bar code:

Autostand Triggering Mode







Worldwide Headquarters  
6001 36th Avenue West  
Everett, Washington 98203  
U.S.A.

tel 425.348.2600

fax 425.355.9551

[www.intermec.com](http://www.intermec.com)

© 2011 Intermec Technologies  
Corporation. All rights reserved.

## SG20B Cordless Scanner + Bluetooth Base Station User's Guide



DOC-SG20B-UG01